

1. Part Names
2. Introduction
3. Direct Button Operation
4. On-Screen Display Menu
5. Application
6. Using a PC
7. Using the touch function
8. Appendix
9. Specifications
10. Trademarks
11. Dimensional Drawings



SHARP

AQUOS Commercial TV

4K Ultra HD Commercial LCD TV
Téléviseur LCD commercial 4K Ultra HD
Televisor LCD commercial 4K Ultra HD

4P-B43EJ2U / 4P-B50EJ2U / 4P-B55EJ2U
4P-B65EJ2U / 4P-B75EJ2U / 4P-B86EJ2U

AQUOS BOARD®

4K Ultra HD Interactive Display
Affichage Interactif 4K Ultra HD
Pantalla Interactiva 4K Ultra HD

4W-B55FT5U / 4W-B65FT5U / 4W-B75FT5U
4W-B86FT5U

OPERATION MANUAL
MODE D'EMPLOI
MANUAL DEL USUARIO

- Please choose your favorite page from the content.
If you want to close the operation manual, press the EXIT button.
Also, if you want to return to the previously displayed page, press the RETURN button.
- Veuillez choisir votre page préférée dans le contenu.
Si vous souhaitez fermer le manuel d'utilisation, appuyez sur le bouton EXIT.
De même, si vous souhaitez revenir à la page précédemment affichée, appuyez sur le bouton RETURN.
- Elija su página favorita del contenido.
Si desea cerrar el manual de operación, presione el botón EXIT.
Además, si desea volver a la página mostrada anteriormente, presione el botón VOLVER.

IFT SHSH4P23-09353



1.	Part Names
2.	Introduction
3.	Direct Button Operation
4.	On-Screen Display Menu
5.	Application
6.	Using a PC
7.	Using the touch function
8.	Appendix
9.	Specifications
10.	Trademarks
11.	Dimensional Drawings

Thank you for your purchase of the Sharp LCD TV. To ensure safety and many years of trouble-free operation of your product, please read the Important Safety Instructions carefully before using this product.

IMPORTANT SAFETY INSTRUCTIONS

Electricity is used to perform many useful functions, but it can also cause personal injuries and property damage if improperly handled. This product has been engineered and manufactured with the highest priority on safety. However, improper use can result in electric shock and/or fire. In order to prevent potential danger, please observe the following instructions when installing, operating and cleaning the product. To ensure your safety and prolong the service life of your LCD TV, please read the following precautions carefully before using the product.

- 1) Read these instructions.
- 2) Keep these instructions.
- 3) Heed all warnings.
- 4) Follow all instructions.
- 5) Do not use this apparatus near water.
- 6) Clean only with dry cloth.
- 7) Do not block any ventilation openings. Install in accordance with the manufacturer's instructions.
- 8) Do not install near any heat sources such as radiators, heat registers, stoves, or other apparatus (including amplifiers) that produce heat.
- 9) Do not defeat the safety purpose of the polarized or grounding-type plug. A polarized plug has two blades with one wider than the other. A grounding type plug has two blades and a third grounding prong. The wide blade or the third prong are provided for your safety. If the provided plug does not fit into your outlet, consult an electrician for replacement of the obsolete outlet.
- 10) Protect the power cord from being walked on or pinched particularly at plugs, convenience receptacles, and the point where they exit from the apparatus.
- 11) Only use attachments/accessories specified by the manufacturer.
- 12) Use only with the cart, stand, tripod, bracket, or table specified by the manufacturer, or sold with the apparatus. When a cart is used, use caution when moving the cart/apparatus combination to avoid injury from tip-over.
- 13) Unplug this apparatus during lightning storms or when unused for long periods of time.
- 14) Refer all servicing to qualified service personnel. Servicing is required when the apparatus has been damaged in any way, such as power-supply cord or plug is damaged, liquid has been spilled or objects have fallen into the apparatus, the apparatus has been exposed to rain or moisture, does not operate normally, or has been dropped.



1.	Part Names
2.	Introduction
3.	Direct Button Operation
4.	On-Screen Display Menu
5.	Application
6.	Using a PC
7.	Using the touch function
8.	Appendix
9.	Specifications
10.	Trademarks
11.	Dimensional Drawings



Additional Safety Information

- 15) Power Sources—This product should be operated only from the type of power source indicated on the marking label. If you are not sure of the type of power supply to your home, consult your product dealer or local power company. For products intended to operate from battery power, or other sources, refer to the operating instructions.
- 16) Overloading—Do not overload wall outlets, extension cords, or integral convenience receptacles as this can result in a risk of fire or electric shock.
- 17) Object and Liquid Entry—Never push objects of any kind into this product through openings as they may touch dangerous voltage points or short-out parts that could result in a fire or electric shock. Never spill liquid of any kind on the product.
- 18) Damage Requiring Service—Unplug this product from the wall outlet and refer servicing to qualified service personnel under the following conditions:
- When the AC cord or plug is damaged.
 - If liquid has been spilled, or objects have fallen into the product.
 - If the product has been exposed to rain or water.
 - If the product does not operate normally by following the operating instructions.
Adjust only those controls that are covered by the operating instructions as an improper adjustment of other controls may result in damage and will often require extensive work by a qualified technician to restore the product to its normal operation.
 - If the product has been dropped or damaged in any way, and
 - When the product exhibits a distinct change in performance - this indicates a need for service.
- 19) Replacement Parts—When replacement parts are required, be sure the service technician has used replacement parts specified by the manufacturer or have the same characteristics as the original part. Unauthorized substitutions may result in fire, electric shock, or other hazards.
- 20) Safety Check—Upon completion of any service or repairs to this product, ask the service technician to perform safety checks to determine that the product is in proper operating condition.
- 21) Wall or ceiling mounting—When mounting the product on a wall or ceiling, be sure to install the product according to the method recommended by the manufacturer.

1. [Part Names](#)
2. [Introduction](#)
3. [Direct Button Operation](#)
4. [On-Screen Display Menu](#)
5. [Application](#)
6. [Using a PC](#)
7. [Using the touch function](#)
8. [Appendix](#)
9. [Specifications](#)
10. [Trademarks](#)
11. [Dimensional Drawings](#)



Outdoor Antenna Grounding — If an outside antenna is connected to the television equipment, be sure the antenna system is grounded so as to provide some protection against voltage surges and built-up static charges. Article 810 of the National Electrical Code, ANSI/ NFPA 70, provides information regarding proper grounding of the mast and supporting structure, grounding of the lead-in wire to an antenna discharge unit, size of grounding conductors, location of antenna-discharge unit, connection to grounding electrodes, and requirements for the grounding electrode.

EXAMPLE OF ANTENNA GROUNDING AS PER NATIONAL ELECTRICAL CODE, ANSI/NFPA 70

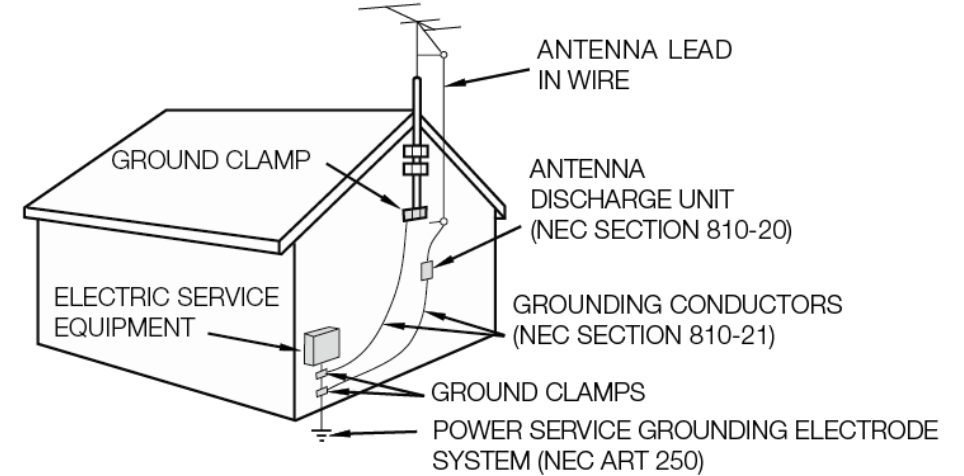

NEC — NATIONAL ELECTRICAL CODE

1. [Part Names](#)
2. [Introduction](#)
3. [Direct Button Operation](#)
4. [On-Screen Display Menu](#)
5. [Application](#)
6. [Using a PC](#)
7. [Using the touch function](#)
8. [Appendix](#)
9. [Specifications](#)
10. [Trademarks](#)
11. [Dimensional Drawings](#)



- **Water and Moisture** — Do not use this product near water - for example, near a bath tub, wash bowl, kitchen sink, or laundry tub; in a wet basement; or near a swimming pool; and the like.
- **Stand** — Do not place the product on an unstable cart, stand, tripod or table. Placing the product on an unstable base can cause the product to fall, resulting in serious personal injuries as well as damage to the product. Use only a cart, stand, tripod, bracket or table recommended by the manufacturer or sold with the product. When mounting the product on a wall, be sure to follow the manufacturer's instructions. Use only the mounting hardware recommended by the manufacturer.
- **Selecting the location** — Select a place with no direct sunlight and good ventilation.
- **Ventilation** — The vents and other openings in the cabinet are designed for ventilation. Do not cover or block these vents and openings since insufficient ventilation can cause overheating and/or shorten the life of the product. Do not place the product on a bed, sofa, rug or other similar surface, since they can block ventilation openings. This product is not designed for built-in installation; do not place the product in an enclosed place such as a bookcase or rack, unless proper ventilation is provided or the manufacturer's instructions are followed.
- **The front panel used in this product is made of glass.** Therefore, it can break when the product is dropped or applied with impact. Be careful not to be injured by broken glass pieces in case the panel breaks.
- **Heat** — The product should be situated away from heat sources such as radiators, heat registers, stoves, or other products (including amplifiers) that produce heat.
- **The Liquid Crystal panel is a very high technology product with 8,294,400 pixels, giving you fine picture details.** Occasionally, a few non-active pixels may appear on the screen as a fixed point of blue, green or red. Please note that this does not affect the performance of your product.
- **Lightning** — For added protection for this television equipment during a lightning storm, or when it is left unattended and unused for long periods of time, unplug it from the wall outlet and disconnect the antenna. This will prevent damage to the equipment due to lightning and power-line surges.
- **Power Lines** — An outside antenna system should not be located in the vicinity of overhead power lines or other electric light or power circuits, or where it can fall into such power lines or circuits. When installing an outside antenna system, extreme care should be taken to keep from touching such power lines or circuits as contact with them might be fatal.
- **To prevent fire, never place any type of candle or flames on the top or near the TV set.**
- **To prevent fire or shock hazard, do not place the AC cord under the TV set or other heavy items.**

1. [Part Names](#)
2. [Introduction](#)
3. [Direct Button Operation](#)
4. [On-Screen Display Menu](#)
5. [Application](#)
6. [Using a PC](#)
7. [Using the touch function](#)
8. [Appendix](#)
9. [Specifications](#)
10. [Trademarks](#)
11. [Dimensional Drawings](#)

**WARNING – Stability Hazard**

A television set may fall causing serious personal injury or death. Many injuries, particularly to children, can be avoided by taking simple precautions such as:

- ALWAYS use cabinets or stands or mounting method recommended by the manufacturer of the television set.
- ALWAYS use furniture that can safely support the television set.
- ALWAYS ensure the television set is not overhanging the edge of the supporting furniture.
- ALWAYS educate children about the dangers of climbing on furniture to reach the television set or its controls.
- ALWAYS route cords and cables connected to your television so they cannot be tripped over, pulled or grabbed.
- NEVER place a television set in an unstable location.
- NEVER place the television set on tall furniture (for example, cupboards or bookcases) without anchoring both the furniture and the television set to a suitable support.
- NEVER place the television set on cloth or other materials that may be located between the television set and supporting furniture.
- NEVER place items that might tempt children to climb, such as toys and remote controls, on the top of the television or furniture on which the television is placed.

If the existing television set is going to be retained and relocated, the same considerations as above should be applied.

CAUTION

- Replacement of a battery with an incorrect type that can defeat a safeguard (for example, in the case of some lithium battery types).
- Disposal of a battery into fire or a hot oven, or mechanically crushing or cutting of a battery, that can result in an explosion.
- Leaving a battery in an extremely high temperature surrounding environment that can result in an explosion or the leakage of flammable liquid or gas.
- A battery subjected to extremely low air pressure that may result in an explosion or the leakage of flammable liquid or gas.
- Risk of fire or explosion if the battery is replaced by an incorrect type.

1. Part Names
2. Introduction
3. Direct Button Operation
4. On-Screen Display Menu
5. Application
6. Using a PC
7. Using the touch function
8. Appendix
9. Specifications
10. Trademarks
11. Dimensional Drawings



- Do not display a still picture for a long time, as this could cause an afterimage to remain.
- To prevent fire or shock hazard, do not expose this product to dripping or splashing. No objects filled with liquids, such as vases, should be placed on the product.
- Do not insert foreign objects into the product. Inserting objects in the air vents or other openings may result in fire or electric shock. Exercise special caution when using the product around children.

Precautions when transporting the TV (For SHARP dealer and service engineers)

- When transporting the TV, never carry it by holding or otherwise putting pressure onto the display. Be sure to always carry the TV by four people.

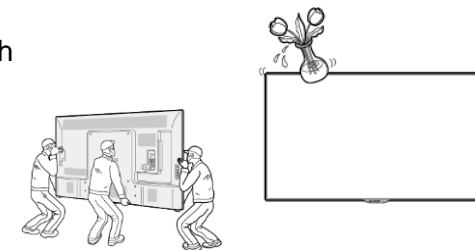

Do not install the TV in a location in which it will be subject to water drops such as underneath an air conditioning unit or in the vicinity of a humidifier

- Water drops falling onto the TV and water entering inside it may result in fire, electric shock, or malfunctions.
- We recommend that you install the TV at least 3.3 ft (1m) away from the outlet of an air conditioner.

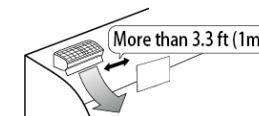

Caring for the cabinet

- Use a soft cloth (cotton, flannel, etc.) and gently wipe the surface of the cabinet.
- Using a chemical cloth (wet/dry sheet type cloth, etc.) may deform the components of the main unit cabinet or cause cracking.
- Wiping with a hard cloth or using strong force may scratch the surface of the cabinet.
- If the cabinet is very dirty, wipe with a soft cloth (cotton, flannel, etc.) soaked in neutral detergent diluted with water and thoroughly wrung out, and then wipe with a soft dry cloth.
- Avoid using benzene, thinner, and other solvents, as these may deform the cabinet and cause the paint to peel off.
- Do not apply insecticides or other volatile liquids.
- Also, do not allow the cabinet to remain in contact with rubber or vinyl products for a long period of time. Plasticizers inside the plastic may cause the cabinet to deform and cause the paint to peel off

Caring for the front panel

- Turn off the main power and unplug the AC cord from the wall outlet before handling.
- Gently wipe the surface of the front panel with a soft cloth (cotton, flannel, etc.). To protect the front panel, do not use a dirty cloth, liquid cleaners, or a chemical cloth (wet/dry sheet type cloth, etc.). This may damage the surface of the front panel.
- Wiping with a hard cloth or using strong force may scratch the surface of the front panel.
- Use a soft damp cloth to gently wipe the front panel when it is really dirty. (It may scratch the surface of the front panel when wiped strongly.)
- If the front panel is dusty, use an anti-static brush, which is commercially available, to clean it.
- To avoid scratching the frame or screen, please use a soft, lint free cloth for cleaning. Approved cleaning cloths are available directly from Sharp in single (00Z-LCD-CLOTH) or triple (00Z-LCD-CLOTH-3) packs. Call 1-877-PRO-ADV1 (1-877-776-2381) for ordering, or VISIT <http://www.sharpusa.com>.

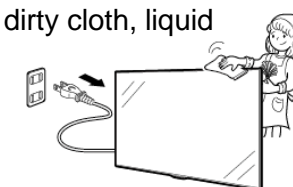

1.	Part Names
2.	Introduction
3.	Direct Button Operation
4.	On-Screen Display Menu
5.	Application
6.	Using a PC
7.	Using the touch function
8.	Appendix
9.	Specifications
10.	Trademarks
11.	Dimensional Drawings



Especially for child safety

- Don't allow children to climb on or play with the TV.
- Don't place the TV on furniture that can easily be used as steps, such as a chest of drawers.
- Remember that children can become excited while watching a program, especially on a "larger than life" TV. Care should be taken to place or install the TV where it cannot be pushed, pulled over, or knocked down.
- Care should be taken to route all cords and cables connected to the TV so that they cannot be pulled or grabbed by curious children.

FCC

This device complies with part 15 of the FCC Rules. Operation is subject to the following two conditions:

(1) This device may not cause harmful interference, and (2) this device must accept any interference received, including interference that may cause undesired operation. Changes or modifications not expressly approved by the party responsible for compliance could void the user's authority to operate the equipment. To comply with the FCC RF exposure compliance requirements, this device and its antenna must not be co-located or operated in conjunction with any other antenna or transmitter.



IMPORTANT SAFETY INSTRUCTIONS

1. Part Names

- 1-1. TV (4P-B43EJ2U / 4P-B50EJ2U / 4P-B55EJ2U / 4P-B65EJ2U / 4P-B75EJ2U / 4P-B86EJ2U)
- 1-2. TV (4W-B55FT5U / 4W-B65FT5U / 4W-B75FT5U / 4W-B86FT5U)
- 1-3. Remote Control Unit

2. Introduction

- 2-1. Initial Installation

3. Direct Button Operation

- 3-1. Changing Input Source
- 3-2. Changing Channels
- 3-3. Changing Volume / MUTE
- 3-4. Displaying MANUAL
- 3-5. Displaying Current Input Mode
- 3-6. Sleep Timer
- 3-7. APPS
- 3-8. CEC MENU

4. On-Screen Display Menu

- 4-1. Introduction
- 4-2. Menu Operation Buttons
- 4-3. Video Settings
- 4-4. Audio Settings
- 4-5. Setup
- 4-6. Parental Control
- 4-7. About

5. Application

- 5-1. MMP - Video playback
- 5-2. OPEN BROWSER
- 5-3. ScreenCast

6. Using a PC

- 6-1. Control of the TV
- 6-2. PC Compatibility Chart/AV Compatibility Chart

7. Using the touch function

- 7-1. Computer connection
- 7-2. Touch actions

8. Appendix

- 8-1. Setting the TV on the Wall
- 8-2. Troubleshooting

9. Specifications

- 9-1. TV (4P-B43EJ2U / 4P-B50EJ2U / 4P-B55EJ2U / 4P-B65EJ2U / 4P-B75EJ2U / 4P-B86EJ2U)
- 9-2. TV (4W-B55FT5U / 4W-B65FT5U / 4W-B75FT5U / 4W-B86FT5U)
- 9-3. Wireless LAN

10. Trademarks

11. Dimensional Drawings

1. [Part Names](#)2. [Introduction](#)3. [Direct Button Operation](#)4. [On-Screen Display Menu](#)5. [Application](#)6. [Using a PC](#)7. [Using the touch function](#)8. [Appendix](#)9. [Specifications](#)10. [Trademarks](#)11. [Dimensional Drawings](#)

1. Part Names

1. TV (4P-B43EJ2U / 4P-B50EJ2U / 4P-B55EJ2U / 4P-B65EJ2U / 4P-B75EJ2U / 4P-B86EJ2U)

2. TV (4W-B55FT5U / 4P-B65FT5U / 4P-B75FT5U / 4P-B86FT5U)

3. Remote Controller

2. Introduction

3. Direct Button Operation

4. On-Screen Display Menu

5. Application

6. Using a PC

7. Using the touch function

8. Appendix

9. Specifications

10. Trademarks

11. Dimensional Drawings

(Front)

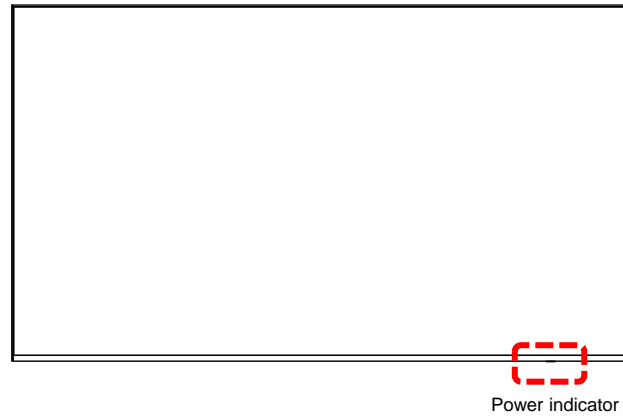

(Rear)

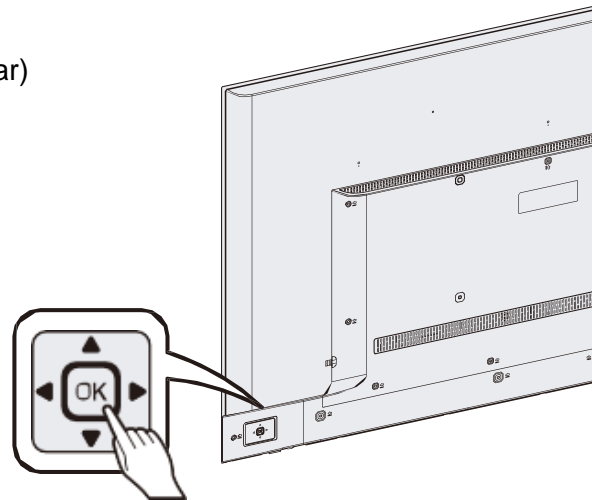

(Rear)

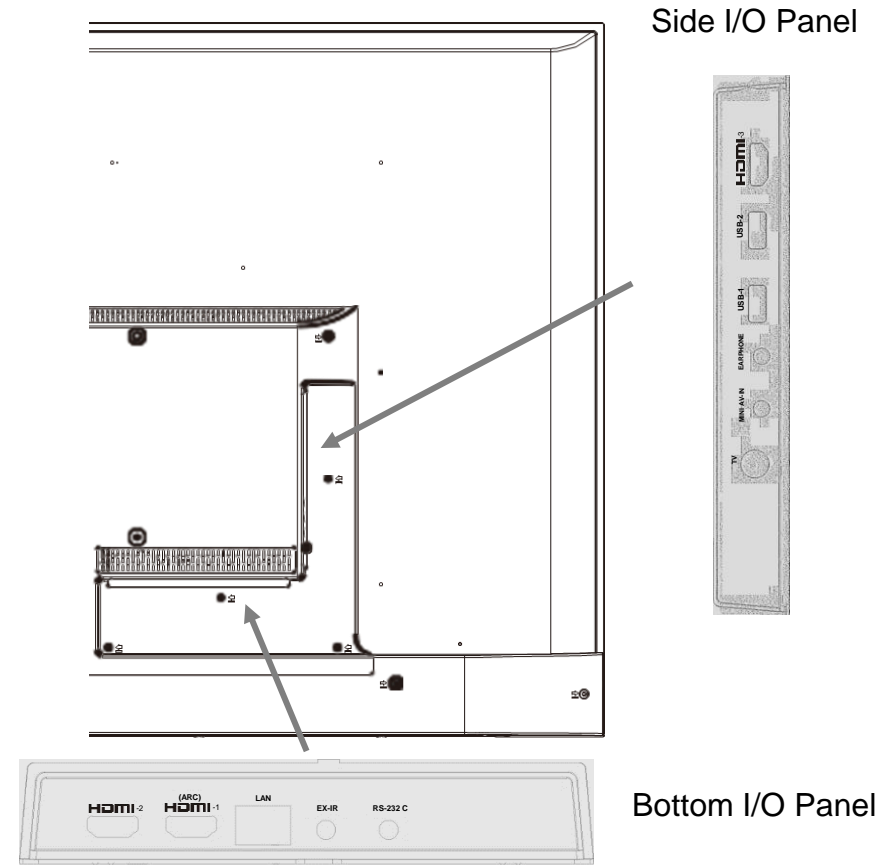

- The illustrations and on-screen displays in this operation manual are for explanation purposes and may vary slightly from the actual operations.
- The examples used throughout this manual are based on the 4P-B75EJ2U model.

1. Part Names

1. TV (4P-B43EJ2U / 4P-B50EJ2U / 4P-B55EJ2U / 4P-B65EJ2U / 4P-B75EJ2U / 4P-B86EJ2U)

2. TV (4W-B55FT5U / 4P-B65FT5U / 4P-B75FT5U / 4P-B86FT5U)

3. Remote Controller

2. Introduction

3. Direct Button Operation

4. On-Screen Display Menu

5. Application

6. Using a PC

7. Using the touch function

8. Appendix

9. Specifications

10. Trademarks

11. Dimensional Drawings

(Front)

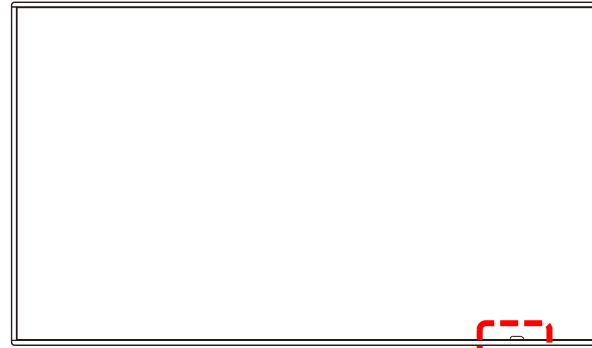

Power indicator

(Rear)

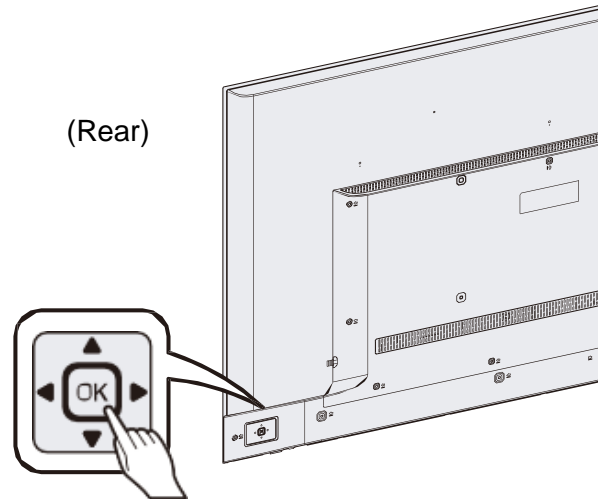

(Rear)

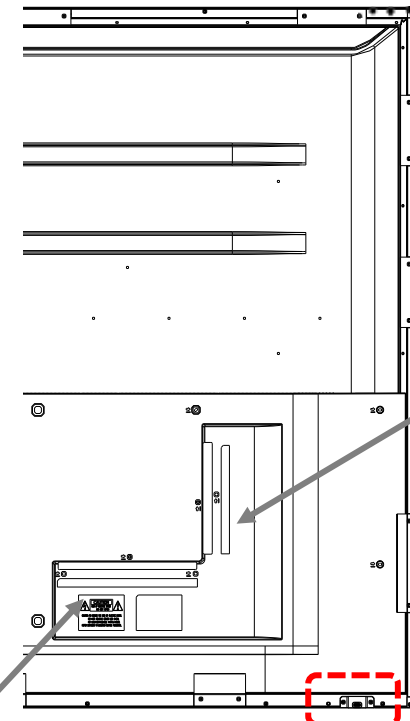

Side I/O Panel



Bottom I/O Panel

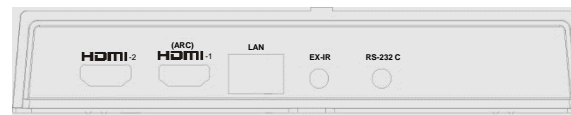

USB Type-C
(for Touch panel only)

USB



- The illustrations and on-screen displays in this operation manual are for explanation purposes and may vary slightly from the actual operations.
- The examples used throughout this manual are based on the 4W-B75FT5U model.

1. Part Names

1. TV (4P-B43EJ2U / 4P-B50EJ2U / 4P-B55EJ2U / 4P-B65EJ2U / 4P-B75EJ2U / 4P-B86EJ2U)

2. TV (4W-B55FT5U / 4P-B65FT5U / 4P-B75FT5U / 4P-B86FT5U)

3. Remote Controller

2. Introduction

3. Direct Button Operation

4. On-Screen Display Menu

5. Application

6. Using a PC

7. Using the touch function

8. Appendix

9. Specifications

10. Trademarks

11. Dimensional Drawings



1 POWER: Switch the TV power on or enter standby.

2 DISPLAY: Display the channel information.

3 SLEEP: Set the sleep time (See “Direct Button Operation” > “Sleep Timer”)

4 0–9: Set the channel. (See “Direct Button Operation” > “Changing Channels”)

5 • (DOT): Set the channel. (See “Direct Button Operation” > “Changing Channels”)

6 OPTION: Display the HDMI CEC setting MENU screen. (See “Direct Button Operation” > “CEC Menu”)

7 VOL+/-: Set the volume. (See “Direct Button Operation” > “Changing Volume / MUTE”)

8 AUDIO: Function on TV Input. It depends of the audio type on the channel.

9 MUTE: Mute the sound. (See “Direct Button Operation” > “Changing Volume / MUTE”)

10 [left] / [right] / [up] / [down] (ENTER): Select a desired item on the screen.

11 EXIT: Exits Menu and APPS screen.

12 A/B/C/D: These buttons work as function keys and are different depending on the feature in use. Use according to OSD.

13 MANUAL: Display the operation manual. (See “Direct Button Operation” > “Displaying Manual”)

14 APPS: Display the application window. (See “Direct Button Operation” > “APPS”)

15 INPUT: Select a TV input source. (See “Direct Button Operation” > “Changing Input Source”)

16 CH: Select the channel. (See “Direct Button Operation” > “Changing Channels”)

17 MENU: Display the menu screen. (See “On Screen Display Menu” > “Introduction”)

18 RETURN: Return to previous menu screen.

NOTE

- When using the remote control unit, point it at the TV.

1. Part Names
2. Introduction
 1. Initial Installation
3. Direct Button Operation
4. On-Screen Display Menu
5. Application
6. Using a PC
7. Using the touch function
8. Appendix
9. Specifications
10. Trademarks
11. Dimensional Drawings



Operation after first power-on

When the monitor is turned on for the first time after being shipped from the factory, the Initial Setup screen will be displayed.

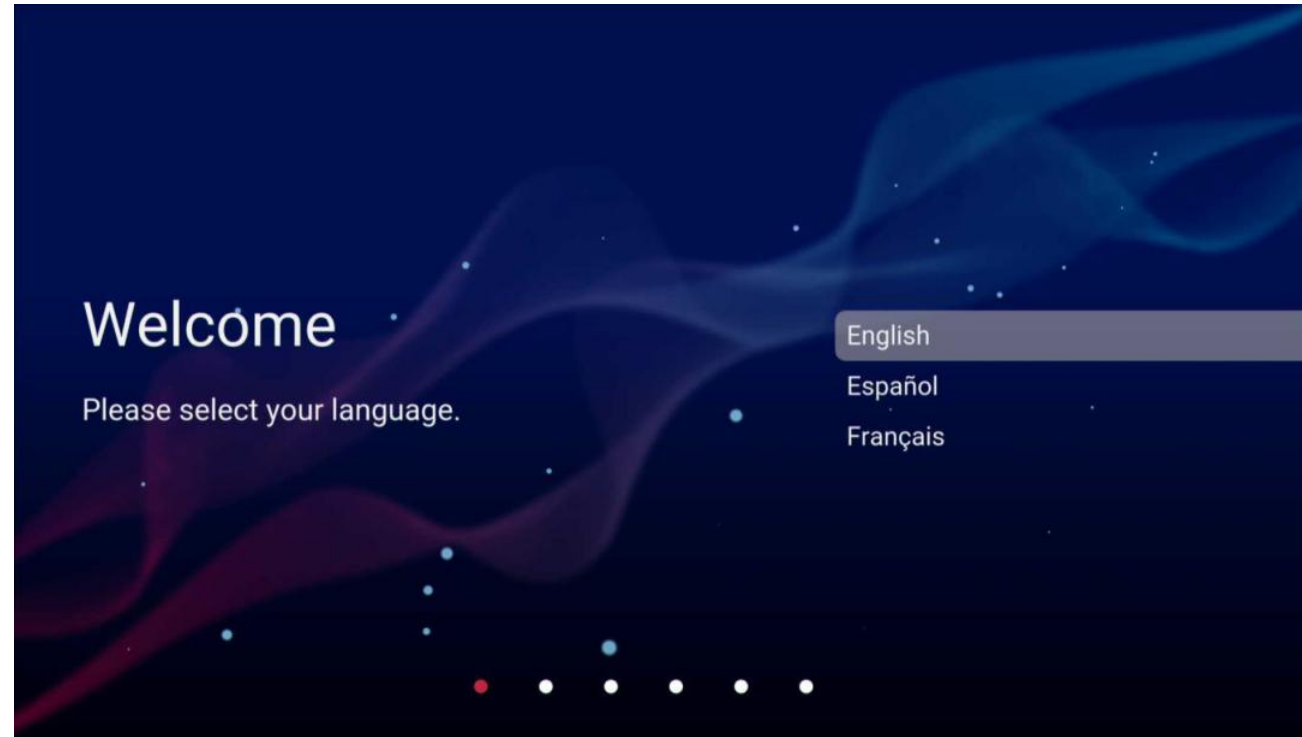

NOTE

- You can change the TV configuration after finishing the Initial Setup by using "SETTINGS" on Menu.
- Regarding password of display, these are set as default as below;
 - System password: 1234
 - Public mode password : 027You can also change these password from "MENU" after initial setup.

To view external source images, select the input source by pressing **INPUT** on the remote control unit.



- You can also select the input source by pressing INPUT.
- Each time INPUT is pressed, the input source toggles.



Example

Main	
TV	✓
Composite	
HDMI 1	
HDMI 2	
HDMI 3	
USB	

- 1 Press INPUT.
 - The INPUT list screen displays.
- 2 Press ▲/▼ to select the input source.
 - An image from the selected source automatically displays.



You can change channels in several ways.

Method 1

Using \wedge / \vee on the remote control unit or on the TV.

Method 2

Using remote control buttons 0-9, • (DOT).

Examples:

To select a 1 or 2-digit channel number (e. g., Channel 5):

Press 5 → ENTER

To select a 3-digit channel number (e. g., Channel 115):

Press 1 → 1 → 5 → ENTER

To select a 4-digit channel number (e. g., Channel 22.1):

Press 2 → 2 → • (DOT) → 1 → ENTER

NOTE

- When selecting a 1-digit channel number, it is not necessary to press 0 before the number.
- When you enter 0-9 only, channel selection will be made if there is no operation within a few seconds.
- If you push "0" by itself, nothing will happen.
- Complete the above steps within a few seconds.
- When you enter 0-9 and • (DOT), channel selection will be made if there is no operation within a few seconds.

1.	Part Names
2.	Introduction
3.	Direct Button Operation
1.	Changing Input Source
2.	Changing Channels
3.	Changing Volume / MUTE
4.	Displaying Manual
5.	Displaying Current Input Mode
6.	Sleep Timer
7.	APPS
8.	CEC Menu
4.	On-Screen Display Menu
5.	Application
6.	Using a PC
7.	Using the touch function
8.	Appendix
9.	Specifications
10.	Trademarks
11.	Dimensional Drawings

1.	Part Names
2.	Introduction
3.	Direct Button Operation
1.	Changing Input Source
2.	Changing Channels
3.	Changing Volume / MUTE
4.	Displaying Manual
5.	Displaying Current Input Mode
6.	Sleep Timer
7.	APPS
8.	CEC Menu
4.	On-Screen Display Menu
5.	Application
6.	Using a PC
7.	Using the touch function
8.	Appendix
9.	Specifications
10.	Trademarks
11.	Dimensional Drawings



Changing volume

You can change the volume by pressing VOL +/- on the TV or on the remote control unit.

- To increase the volume, press VOL +.
- To decrease the volume, press VOL -.



MUTE

Press  Mute button will mute audio. And screen will show mute icon at bottom of screen.

NOTE

- Mute can be cancelled by pressing VOL +/- or MUTE.

- 1. Part Names
- 2. Introduction
- 3. Direct Button Operation
 - 1. Changing Input Source
 - 2. Changing Channels
 - 3. Changing Volume / MUTE
 - 4. Displaying Manual
 - 5. Displaying Current Input Mode
 - 6. Sleep Timer
 - 7. APPS
 - 8. CEC Menu
- 4. On-Screen Display Menu
- 5. Application
- 6. Using a PC
- 7. Using the touch function
- 8. Appendix
- 9. Specifications
- 10. Trademarks
- 11. Dimensional Drawings



To display this document, press "MANUAL" key on remote control.



1. Part Names
2. Introduction
3. Direct Button Operation
 1. Changing Input Source
 2. Changing Channels
 3. Changing Volume / MUTE
 4. Displaying Manual
 5. Displaying Current Input Mode
 6. Sleep Timer
 7. APPS
 8. CEC Menu
4. On-Screen Display Menu
 5. Application
 6. Using a PC
 7. Using the touch function
8. Appendix
9. Specifications
10. Trademarks
11. Dimensional Drawings

>> Direct Button Operation

<< Displaying Current Input Mode



Display current source when you select some of AV input source TV, Composite or HDMI 1 to 3

**NOTE**

- OSD message is not displayed if other functions are enabled (e.g. APPS, MENU, etc).
- If its necessary to return to AV input mode (TV, Composite, HDMI 1-3) use [EXIT] key.

- 1. Part Names
- 2. Introduction
- 3. Direct Button Operation
 - 1. Changing Input Source
 - 2. Changing Channels
 - 3. Changing Volume / MUTE
 - 4. Displaying Manual
 - 5. Displaying Current Input Mode
 - 6. Sleep Timer
 - 7. APPS
 - 8. CEC Menu
- 4. On-Screen Display Menu
- 5. Application
- 6. Using a PC
- 7. Using the touch function
- 8. Appendix
- 9. Specifications
- 10. Trademarks
- 11. Dimensional Drawings



Sleep timer is used to turn off the TV automatically based on the settings without having to press the power button on the remote control or the panel.

Press "Sleep" button to adjust the sleep timer to turn OFF the TV automatically.

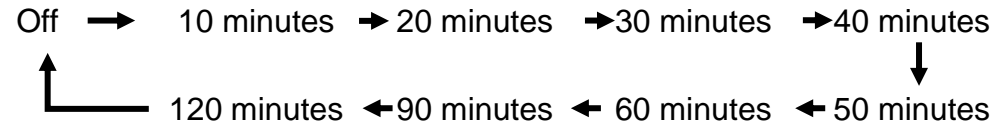

After setting Sleep timer, the countdown will start. To show the countdown press "SLEEP" button once timer is set. When 1 minute is remaining on timer, a prompt dialog box will pop up.

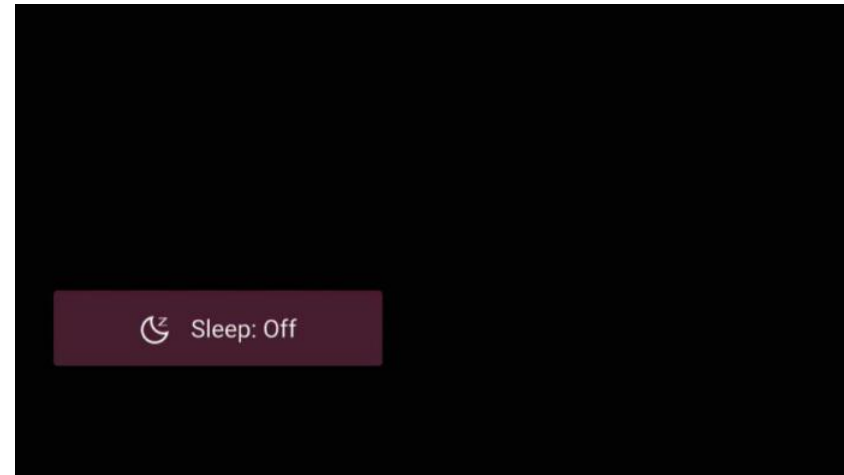

NOTE

- Select "Off" by pressing SLEEP to cancel the sleep timer.
- The TV will enter standby when the remaining time reaches 0.

1.	Part Names
2.	Introduction
3.	Direct Button Operation
1.	Changing Input Source
2.	Changing Channels
3.	Changing Volume / MUTE
4.	Displaying Manual
5.	Displaying Current Input Mode
6.	Sleep Timer
7.	APPS
8.	CEC Menu
4.	On-Screen Display Menu
5.	Application
6.	Using a PC
7.	Using the touch function
8.	Appendix
9.	Specifications
10.	Trademarks
11.	Dimensional Drawings



Allows you to directly operate various types of applications

1. Press APPS to display the application window.
2. Select apps using [left] / [right] and [ENTER] to launch apps desired.

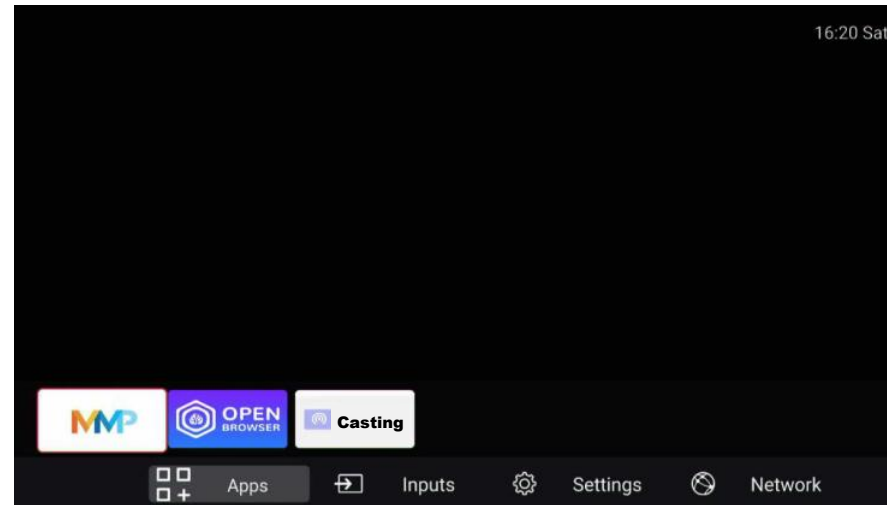
**NOTE**

- See "Application" for details of viewable applications.
- When this function is not available, "Cannot operate this function now" will display.

- 1. Part Names
- 2. Introduction
- 3. Direct Button Operation
 - 1. Changing Input Source
 - 2. Changing Channels
 - 3. Changing Volume / MUTE
 - 4. Displaying Manual
 - 5. Displaying Current Input Mode
 - 6. Sleep Timer
 - 7. APPS
 - 8. CEC Menu
- 4. On-Screen Display Menu
- 5. Application
- 6. Using a PC
- 7. Using the touch function
- 8. Appendix
- 9. Specifications
- 10. Trademarks
- 11. Dimensional Drawings



Press "OPTION" to enter CEC menu

1. Connected CEC Device (Ex: AVR) to HDMI port.
2. Press "OPTION" key to enter CEC Menu, to enable CEC and ARC functions.

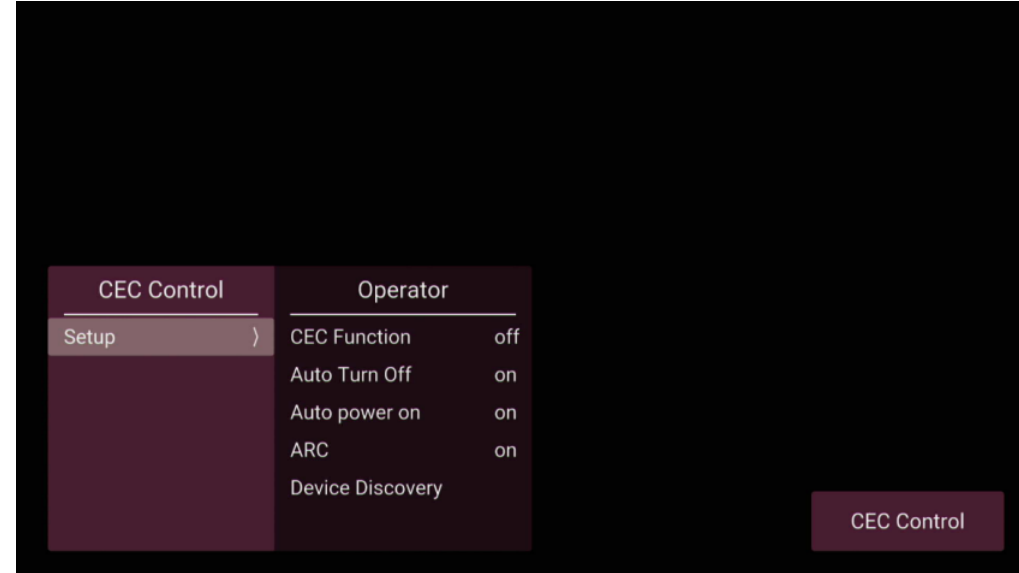

CEC Function	When CEC Function is On, CEC switch is enabled
Auto turn off	When Auto turn off is on, CEC device will auto turn off after the TV goes into standby mode
Auto power on	When Auto power is enabled, if the CEC device is turned on, the TV will turn on accordingly
ARC	Enable or Disable Audio System
Device Discovery	List of found devices connected by CEC.

- 1. Part Names
- 2. Introduction
- 3. Direct Button Operation
 - 1. Changing Input Source
 - 2. Changing Channels
 - 3. Changing Volume / MUTE
 - 4. Displaying Manual
 - 5. Displaying Current Input Mode
 - 6. Sleep Timer
 - 7. APPS
 - 8. CEC Menu
- 4. On-Screen Display Menu
- 5. Application
- 6. Using a PC
- 7. Using the touch function
- 8. Appendix
- 9. Specifications
- 10. Trademarks
- 11. Dimensional Drawings



3. Highlight Device on and select "Standby / Power On".



Operator Standby	When standby is enabled, CEC device will enter standby mode
Operator Power on	When power on is enabled, CEC device will enter power on state

- 1. Part Names
- 2. Introduction
- 3. Direct Button Operation
- 4. On-Screen Display Menu
 - 1. Introduction
 - 2. Menu Operation Buttons
 - 3. Video / Audio Settings
 - 4. Setup
 - 5. Parental Control
- 5. Application
- 6. Using a PC
- 7. Using the touch function
- 8. Appendix
- 9. Specifications
- 10. Trademarks
- 11. Dimensional Drawings



This menu allows you to configure the TV settings.

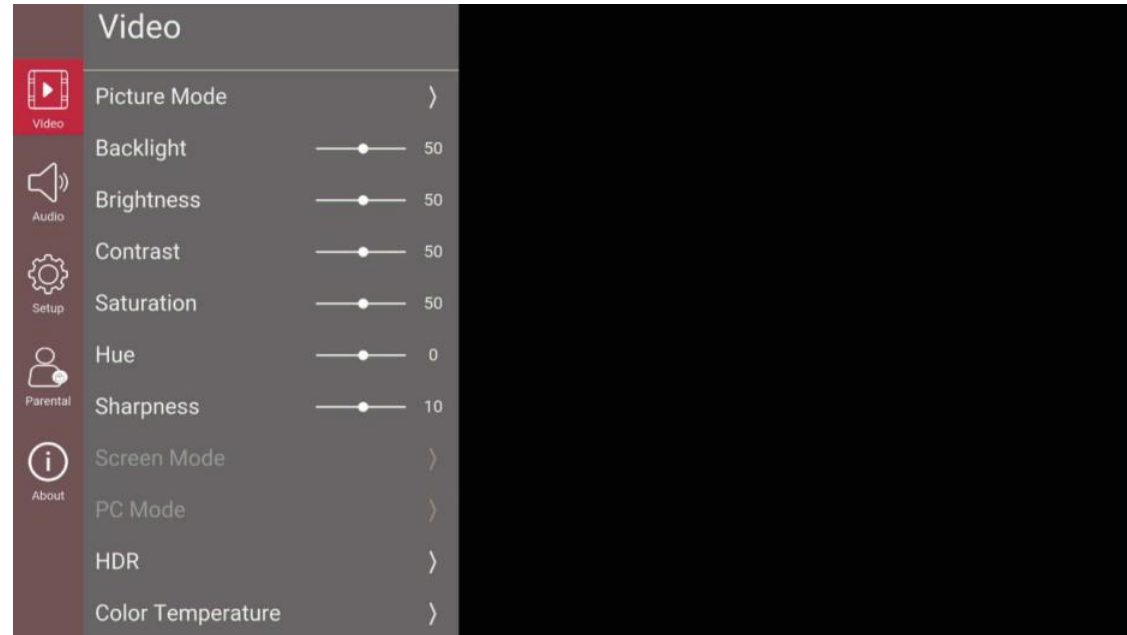

1. Settings Menus are displayed in the purple left bar.
2. Default selected Item is highlighted in red.
3. Selected sub-item is highlighted in red.

- 1. Part Names
- 2. Introduction
- 3. Direct Button Operation
- 4. On-Screen Display Menu
 - 1. Introduction
 - 2. Menu Operation Buttons
 - 3. Video / Audio Settings
 - 4. Setup
 - 5. Parental Control
- 5. Application
- 6. Using a PC
- 7. Using the touch function
- 8. Appendix
- 9. Specifications
- 10. Trademarks
- 11. Dimensional Drawings



About Menu Items

- Some menu items may not be displayed depending on the selected input source.

NOTE

- The screens in the operation manual are for explanation purposes (some are enlarged, others cropped) and may vary slightly from the actual screens.
- The order of explanations for each menu item in the following pages is not necessarily in accordance with the alignment of the items on the screen.

1. Part Names
2. Introduction
3. Direct Button Operation
4. On-Screen Display Menu
 1. Introduction
 2. Menu Operation Buttons
 3. Video / Audio Settings
 4. Setup
 5. Parental Control
5. Application
6. Using a PC
7. Using the touch function
8. Appendix
9. Specifications
10. Trademarks
11. Dimensional Drawings

>> On-Screen Display Menu

<< Menu Operation Buttons



Using the remote control

Use the following buttons on the remote control to operate the menu.

MENU: Press to open or close the menu screen.

▲/▼ ◀/▶ Press to select a desired item on the screen or adjust a selected item.

ENTER: Press to go to the next step or complete the setting.

RETURN: Press to return to the previous step.

Using the control panel of the TV

PUSH : Power ON/OFF (Same as remote control)

Cursor Up / Down : CH Up / Down

Cursor Right / Left : VOL+/-

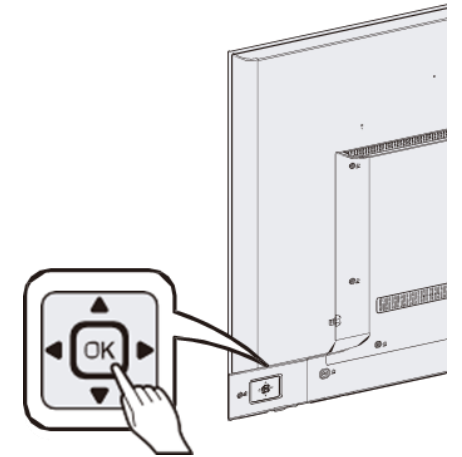

NOTE

- Control panel cannot support all functions.
- Use remote control for all TV functions.

- 1. Part Names
- 2. Introduction
- 3. Direct Button Operation
- 4. On-Screen Display Menu
 - 1. Introduction
 - 2. Menu Operation Buttons
 - 3. Video / Audio Settings
 - 4. Setup
 - 5. Parental Control
- 5. Application
- 6. Using a PC
- 7. Using the touch function
- 8. Appendix
- 9. Specifications
- 10. Trademarks
- 11. Dimensional Drawings



Adjusts the picture to your preference with the following picture settings.

Selected item	
Picture mode	To adjust video settings by the default selections: Standard, Movie, Thru, PC, Dynamic, Dynamic (Fixed) and User. The different selections of Picture Mode will affect the option value of Backlight, Brightness, Contrast, Saturation, Tint and Sharpness.
Picture Size	The Picture Size UI is only displayed when current source has signal. To adjust screen size Auto / Normal / Zoom / Dot by Dot / 4:3 / 14:9 / 16:9
Backlight	When current progress option is available, Press ENTER key to pop up this progress bar view. To adjust the back light to brighten or darken: 0 ~ 100.
Brightness	Adjust brightness of screen. Adjustment range: 0 (Darkest) - 100 (Brightest)
Contrast	Adjust contrast of screen. Adjustment range: 0 (Lowest) – 100 (Highest)
Saturation	Adjust saturation of screen. Adjustment range: 0 (Lowest) – 100 (Highest)
Tint	Adjust Tint of screen. Adjustment range: -50 (Low) – 50 (High)
Sharpness	Adjust sharpness of screen. Adjustment range: 0 (Weak) – 20 (Strong)
Color Temperature	To adjust the color temperature: User, Cool, Standard and Warm. The different selection of color temperature will affect the option value of R Gain, G Gain and B Gain.
DNR	DNR is Digital Noise Reduction. To adjust the level of reducing the appearance of digitizing error caused by the compression: Medium, Strong, Auto, Off and Low.
Reset to Default	Reset setting value to default

- 1. [Part Names](#)
- 2. [Introduction](#)
- 3. [Direct Button Operation](#)
- 4. [On-Screen Display Menu](#)
 - 1. [Introduction](#)
 - 2. [Menu Operation Buttons](#)
 - 3. [Video / Audio Settings](#)
 - 4. [Setup](#)
 - 5. [Parental Control](#)
- 5. [Application](#)
- 6. [Using a PC](#)
- 7. [Using the touch function](#)
- 8. [Appendix](#)
- 9. [Specifications](#)
- 10. [Trademarks](#)
- 11. [Dimensional Drawings](#)

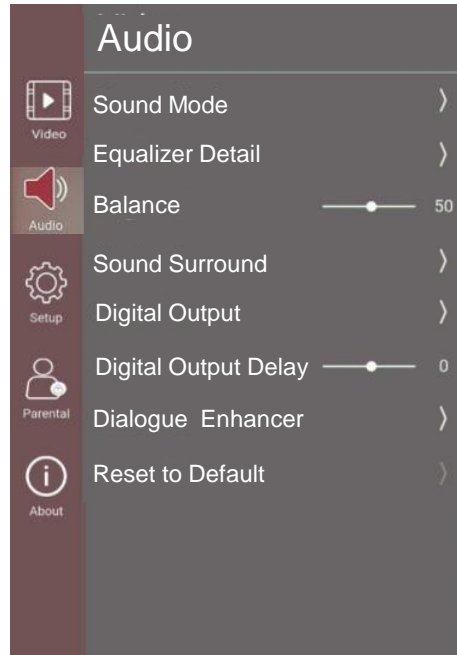

Adjusts the audio to your preference with the following audio settings.

Selected item (continue)	
Sound Mode	To adjust the Surround Style: User, Standard, Sport, Movie and Music.
Equalizer Detail	To adjust the EQUALIZER 50 ~ 50. Submenu by Frequency band: 120, 500, 1500, 5000 and 10000Hz
Balance	To adjust the left or right sound balance: 50 ~ 50.
Sound Surround	To adjust the simulated surround sound: On and Off.
Digital Output	To adjust the SPDIF output: Dolby Digital/PCM/Dolby Digital Plus/Auto
Digital Output Delay	To adjust the SPDIF delay: 0 ~ 250
Dialogue Enhancer	To adjust Dialog Enhancement: Off, Low, Medium and High
Reset to Default	Reset setting value to default

- 1. [Part Names](#)
- 2. [Introduction](#)
- 3. [Direct Button Operation](#)
- 4. [On-Screen Display Menu](#)
 - 1. [Introduction](#)
 - 2. [Menu Operation Buttons](#)
 - 3. [Video / Audio Settings](#)
 - 4. [Setup](#)
 - 5. [Parental Control](#)
- 5. [Application](#)
- 6. [Using a PC](#)
- 7. [Using the touch function](#)
- 8. [Appendix](#)
- 9. [Specifications](#)
- 10. [Trademarks](#)
- 11. [Dimensional Drawings](#)

>> On-Screen Display Menu

<< Setup

The menu Setup page provides OSD Language, Network, DTV Time Setup, CEC Control, HDMI EDID Version, No Signal Power Off, USB Upgrade, Internet Update Check, Public Mode, Auto Play, E-Manual and Reset to Default.

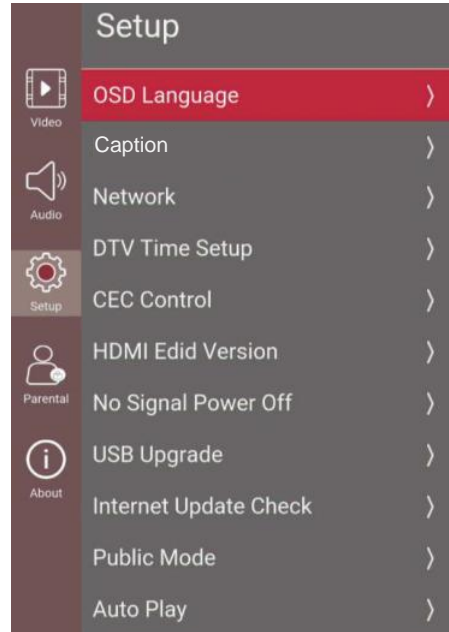

Selected item	
OSD Language	To adjust Language: English, Spanish and French.
Caption	To adjust the caption configuration.
Network	To adjust the network configuration.
DTV Time Setup	To adjust Time related settings: Time zone, Time, Sleep timer and Auto Sleep.
CEC Control	<ol style="list-style-type: none"> 1. Connected CEC Device (Ex: AVR) to HDMI port. 2. Press "OPTION" key to launch CEC Menu, enable CEC Function.
HDMI EDID Version	HDMI EDID Version include : HDMI EDID1.4 / HDMI EDID 2.0 / HDMI AUTO / HDMI EDID 2.1. When set to HDMI AUTO, it can automatic recognition for HDMI EDID 1.4 or HDMI EDID 2.0.
No Signal Power Off	To set "on", Power off when no signal.
USB Upgrade	Plug the USB flash disk to TV with FW (MstarUpgrade.bin), select USB Auto Upgrade, will do upgrade, if name isn't "MstarUpgrade.bin" in USB disk, TV will display "Please insert USB before execute USB Auto Upgrade". Please check SHARP's web-site for downloading FW and detailed information.
Internet Update Check	"Internet Update Check" is the OTA upgrade function. The TV needs to be connected to network before use.
Public Mode	See "Setup" > "Public Mode".

- 1. Part Names
- 2. Introduction
- 3. Direct Button Operation
- 4. On-Screen Display Menu
 - 1. Introduction
 - 2. Menu Operation Buttons
 - 3. Video / Audio Settings
 - 4. Setup
 - 5. Parental Control
- 5. Application
- 6. Using a PC
- 7. Using the touch function
- 8. Appendix
- 9. Specifications
- 10. Trademarks
- 11. Dimensional Drawings

>> On-Screen Display Menu

<< Setup (Continue)

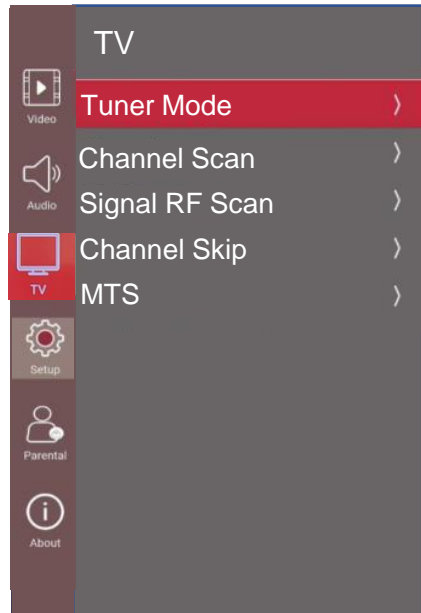
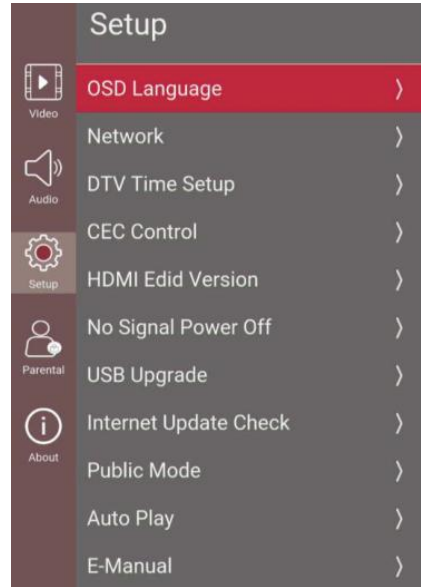

Selected item	
Auto Play	You can automatically start USB media player or web browser (See "Setup" > "Auto Play").
E-Manual	Display on screen manual.
Reset to Default	To reset menu settings to the default values. Press enter key, then insert password, select OK to confirm, Setup Wizard Menu will be displayed automatically after executing Reset to Default.

Selected item	
Tuner Mode	It can select Antenna or Cable.
Channel Scan	Scan available channels both Digital and Analog.
Signal RF Scan	It is digital manual scan. This allow user to scan specific frequency by pressing left or right key on the RF Channel item.
Channel Skip	To select a channel to skip.
MTS	To change audio track (Mono/Stereo/SAP).

- 1. Part Names
- 2. Introduction
- 3. Direct Button Operation
- 4. On-Screen Display Menu
 - 1. Introduction
 - 2. Menu Operation Buttons
 - 3. Video / Audio Settings
 - 4. Setup
 - 5. Parental Control
- 5. Application
- 6. Using a PC
- 7. Using the touch function
- 8. Appendix
- 9. Specifications
- 10. Trademarks
- 11. Dimensional Drawings

>> On-Screen Display Menu

<< Setup (Continue)

Time

You can set power on /off timing by using this menu.

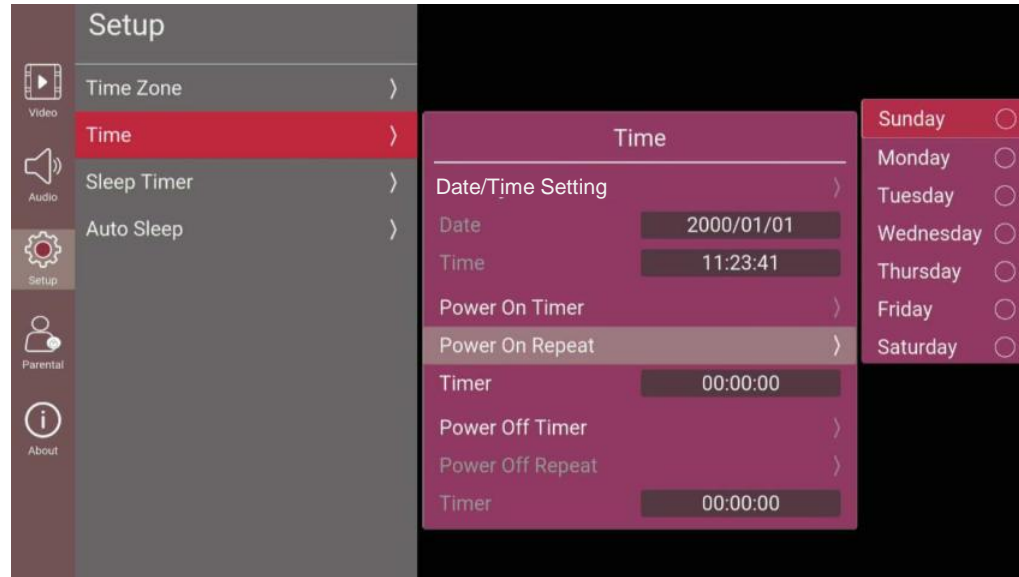

NOTE

- Time setting will be cleared when AC cord is unplugged. Please keep it plugged in if you use time related settings.

Setting item

Selected item	Value	Description
Date/Time Setting	Off / On	Enable Date/Time Setting when turned it on.
Power On Timer	Off / On	Set timer function on /off.
Power on repeat	By day of week	To set the Power On Timer to On first, otherwise the Power On Repeat will be grayed out. Option : Sunday / Monday / Tuesday / Wednesday / Thursday / Friday / Saturday.
Timer	Hour / Minute / Second	Set the Power On Timer (Available when Power On Timer is On).
Power Off timer Power Off repeat Timer (for Power Off)	Each functions are same as settings of "Power On".	

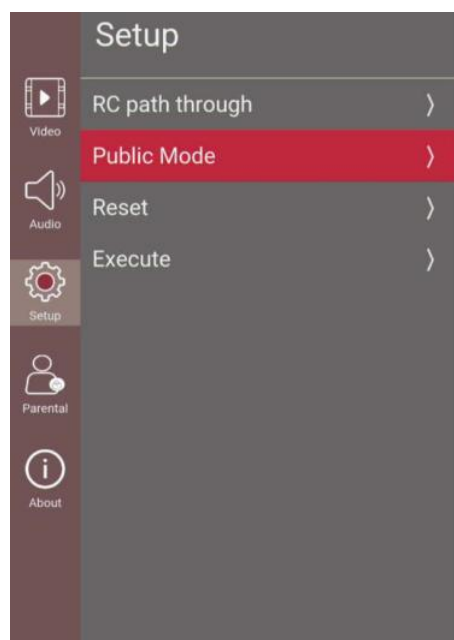

- 1. Part Names
- 2. Introduction
- 3. Direct Button Operation
- 4. On-Screen Display Menu
 - 1. Introduction
 - 2. Menu Operation Buttons
 - 3. Video / Audio Settings
 - 4. Setup
 - 5. Parental Control
- 5. Application
- 6. Using a PC
- 7. Using the touch function
- 8. Appendix
- 9. Specifications
- 10. Trademarks
- 11. Dimensional Drawings

Public Mode

Limit control function to the display for control function to the display by using "Public Mode" menu.

How to enable "Public Mode".

1. [MENU] -> [Setup] -> [Public Mode]
2. Enter the password (set "027" as default).
3. Open the "Public Mode" menu, set "Public Mode" to "On", each item is enabled.

Setting item

Selected item	Value	Description
Power On Fixed	Off / On	"Power key" on main body will be set invalid. The message "No power off by power button." is displayed when power button is pushed.
RC Button	Respond (default)	Remote control is enabled.
	No respond	RC is set as invalid during power on mode.
	Limited	RC is set as invalid except "Power", "Ch. up/down" and "Vol. up/down".
Panel Button	Respond (default)	Panel button is enabled.
	No respond	Panel buttons are set as invalid during power on mode. * Secret command (some key bind) is valid even though during this mode.
Menu button	Respond (default)	Menu button is enabled as usual.
	No respond	Menu button is set as invalid during power on mode.
Maximum Volume	0 - 100	Set maximum volume in public mode.
Volume Fixed	Off (default)	No limitation for volume setting.
	On	Volume setting and MUTE are set invalid by panel button, RC and command control.
	AC CTRL	Start-up at the level specified for a fixed volume at AC CTRL.
	BOOT CTRL	Start-up at the level specified for a fixed volume at start.

NOTE

- If "Power on Fixed" in "Public Mode" is set as "ON", "No input OFF" will be set "OFF" automatically.

- 1. Part Names
- 2. Introduction
- 3. Direct Button Operation
- 4. On-Screen Display Menu
 - 1. Introduction
 - 2. Menu Operation Buttons
 - 3. Video / Audio Settings
 - 4. Setup
 - 5. Parental Control
- 5. Application
- 6. Using a PC
- 7. Using the touch function
- 8. Appendix
- 9. Specifications
- 10. Trademarks
- 11. Dimensional Drawings



Public Mode

Setting item

Selected item	Value	Description
Volume Fixed Level	0 – 100 (default : 30)	Set value of volume when “Volume fixed” is set “On”, “AC CTRL” and “BOOT CTRL”.
Input Mode Fixed	Variable (default)	Panel buttons is enabled.
	Fixed	Launch with input mode of which set by “Input Mode Start”. * When “Input Mode Start” is set “Normal”, this function will be set invalid.
Input Mode Start	Normal (default)	Menu button is enabled.
	TV	
	Composite	
	HDMI 1	Launch with input source selected.
AV Position Fixed	HDMI 2	
	HDMI 3	
	USB	
AV Position Fixed	On / Off	Launch with AV position selected. “Picture Mode” menu is only shown current setting and changing is set invalid.
On Screen Display	On / Off	When set “Off”, OSD is not shown. * If "USB" or "OPENBROWSER" is selected, OSD is enabled.

- 1. Part Names
- 2. Introduction
- 3. Direct Button Operation
- 4. On-Screen Display Menu
 - 1. Introduction
 - 2. Menu Operation Buttons
 - 3. Video / Audio Settings
 - 4. Setup
 - 5. Parental Control
- 5. Application
- 6. Using a PC
- 7. Using the touch function
- 8. Appendix
- 9. Specifications
- 10. Trademarks
- 11. Dimensional Drawings



Public Mode

Setting item

Selected item	Value	Description
RC Path through	Off	Prohibit output IR signal by control "IR-path" port.
	TV RCE	Allow output IR signal to by control "IR-path" port.
	TV RCD	Allow output IR signal by control "IR-path" port and prohibit RC input.
Reset	-	Reset to default.
Execute	-	TV memorized current value set.

NOTE

How to exit from Public Mode:

Once it is set to the "Public Mode" with "On Screen Display" is set to "off". It is unable to exit Public Mode by using remote control.

Here are the steps to exit the Public Mode even if "On Screen Display" is set to "off".

1. Turn off the display.
2. Unplug the display.
3. Plug-in the AC cord and press and hold "OK" button on control panel.
* Remain pressing and holding "OK" button until reboot is complete.
4. The display will be launched with Public Mode only mode.
5. You can change settings of Public Mode.

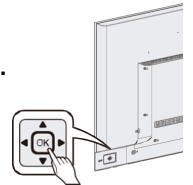

1. Part Names
2. Introduction
3. Direct Button Operation
4. On-Screen Display Menu
 1. Introduction
 2. Menu Operation Buttons
 3. Video / Audio Settings
 4. Setup
 5. Parental Control
5. Application
6. Using a PC
7. Using the touch function
8. Appendix
9. Specifications
10. Trademarks
11. Dimensional Drawings

>> On-Screen Display Menu

<< Setup (Continue)

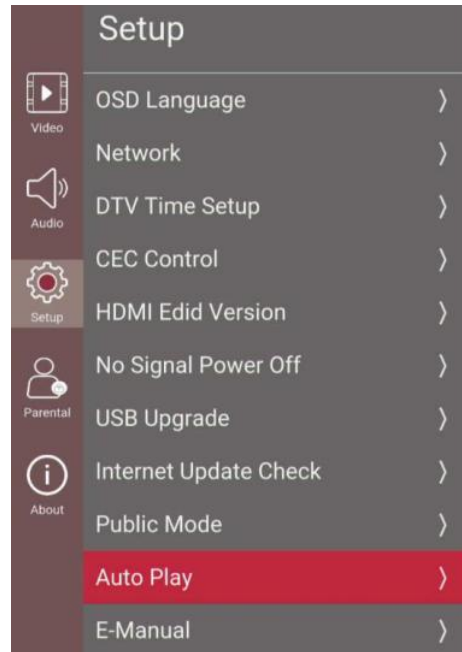

AutoPlay

You can automatically start USB media player or web browser.

Off: Disable AutoPlayUSB: After the power is turned on, the video is played back continuously or slide show of still images automatically starts.

Web Browser: After the power is turned on, the Web Browser starts automatically and displays the Home Page.

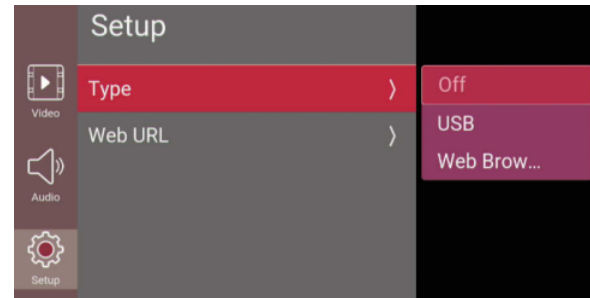

- When both video and still images are saved in "AutoPlay" folder, video has priority and still images will not be played.
- You must insert the USB memory device to the Monitor before turning off the TV.
- If there are images on the USB memory device but they do not appear on the screen, switch to USB mode and check whether the image files on the USB memory device are shown correctly.
- It will be interrupted by any operation. After a few minutes, it will automatically start again.

NOTE

- When more than one video is played back continuously, the screen goes black while the data of the next video is being loaded. To shorten this blackout time, adjust the data size of the content.
- Create a folder named "AutoPlay" in the root directory of the USB memory device (the first directory when the USB memory device is opened), and store into the folder the video or still images you want to playback.

- 1. Part Names
- 2. Introduction
- 3. Direct Button Operation
- 4. On-Screen Display Menu
 - 1. Introduction
 - 2. Menu Operation Buttons
 - 3. Video / Audio Settings
 - 4. Setup
 - 5. Parental Control
- 5. Application
- 6. Using a PC
- 7. Using the touch function
- 8. Appendix
- 9. Specifications
- 10. Trademarks
- 11. Dimensional Drawings

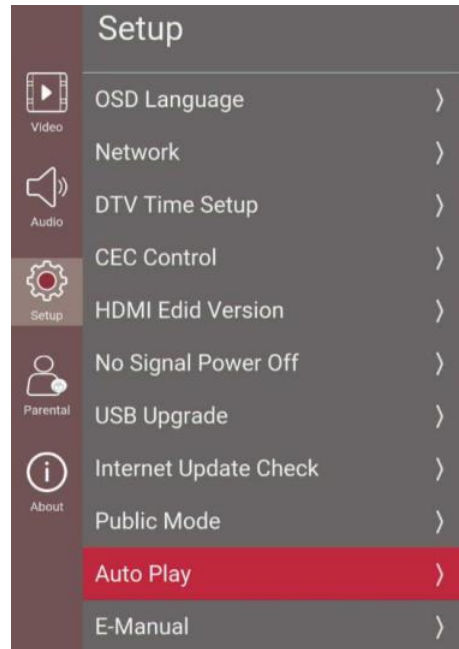

AutoPlay (Continue)

Start up page of Web Browser: It can be configured by two ways.

1. Manual: Enter Web URL by software keyboard

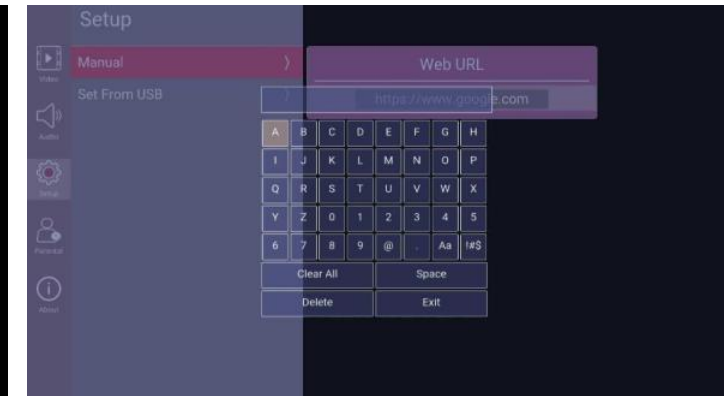
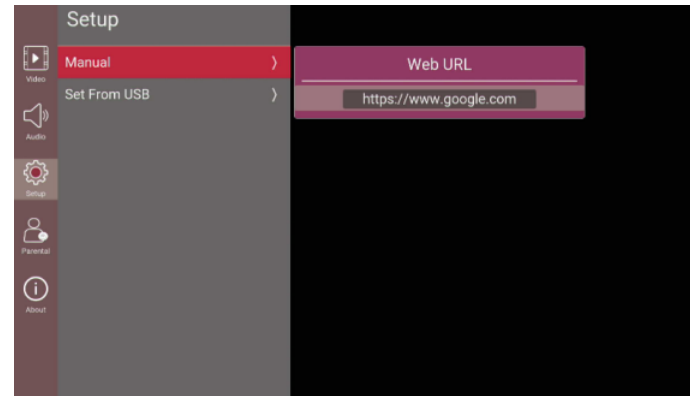

2. Set From USB: Set by using USB flash drive



How to create USB flash drive for start up

1. Create "AutoPlay" folder at root.
2. Create "autoplay.ini" in "AutoPlay" folder.
3. Description scheme of "autoplay.ini"
 [WEB]
 URL = https://foo.bar.com/

- 1. [Part Names](#)
- 2. [Introduction](#)
- 3. [Direct Button Operation](#)
- 4. [On-Screen Display Menu](#)
 - 1. [Introduction](#)
 - 2. [Menu Operation Buttons](#)
 - 3. [Video / Audio Settings](#)
 - 4. [Setup](#)
 - 5. [Parental Control](#)
- 5. [Application](#)
- 6. [Using a PC](#)
- 7. [Using the touch function](#)
- 8. [Appendix](#)
- 9. [Specifications](#)
- 10. [Trademarks](#)
- 11. [Dimensional Drawings](#)

>> On-Screen Display Menu

<< Parental

Parental control

Parental controls provides useful lock function for user to lock function or programs.
This feature can prevent watching some of sources, channels or programs.

Enter Parental control

Enter Menu button -> Select Parental -> Input Password.

Channel Block

➤ It will display channel list and channels can be blocked by select channel item.

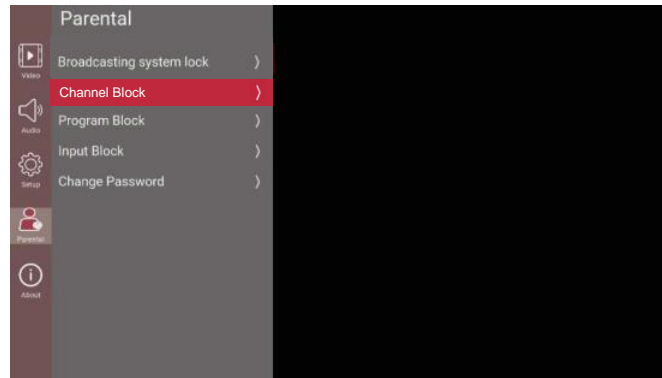

➤ Select Channel Block; the TV channel will be blocked. **A password is needed to watch.**

➤ Change channel, power off/on, AC off/on the channel still locked.



- 1. Part Names
- 2. Introduction
- 3. Direct Button Operation
- 4. On-Screen Display Menu
 - 1. Introduction
 - 2. Menu Operation Buttons
 - 3. Video / Audio Settings
 - 4. Setup
 - 5. Parental Control
- 5. Application
- 6. Using a PC
- 7. Using the touch function
- 8. Appendix
- 9. Specifications
- 10. Trademarks
- 11. Dimensional Drawings

US Region

Select menu Program Restrictions

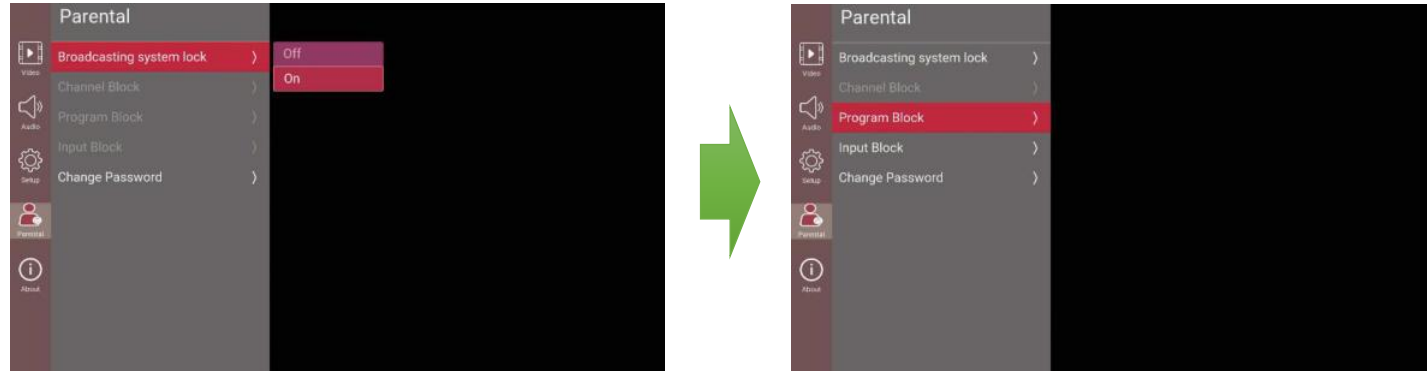

If Program Restrictions is off, user needs to change the settings to ON, otherwise the rest of the lock options are not selectable.

Press "Down" key -> U.S TV Ratings

-> Press "Enter" key and select one items as below

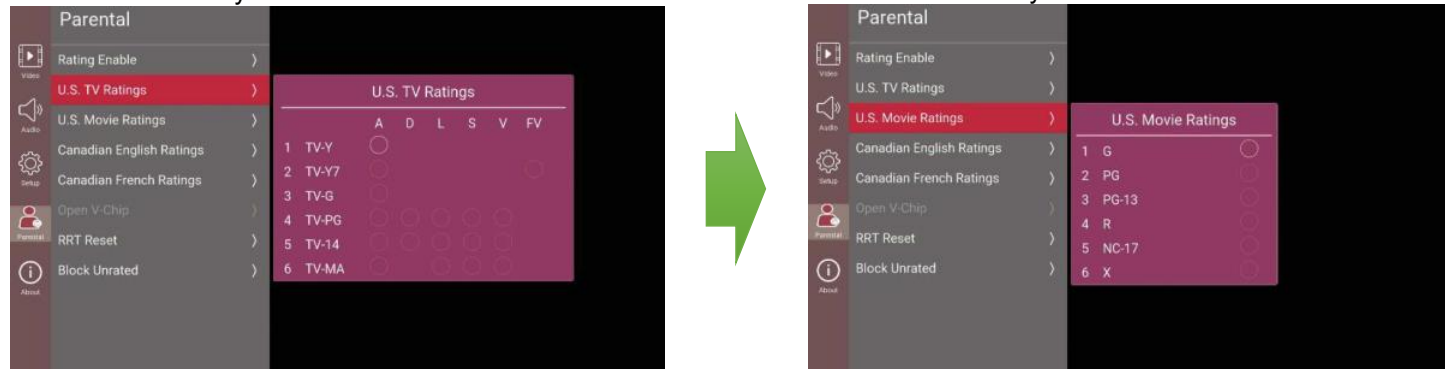

Press "Down" key -> U.S Moving Ratings

-> Press "Enter" key and select one items as below

- 1. [Part Names](#)
- 2. [Introduction](#)
- 3. [Direct Button Operation](#)
- 4. [On-Screen Display Menu](#)
 - 1. [Introduction](#)
 - 2. [Menu Operation Buttons](#)
 - 3. [Video / Audio Settings](#)
 - 4. [Setup](#)
 - 5. [Parental Control](#)
- 5. [Application](#)
- 6. [Using a PC](#)
- 7. [Using the touch function](#)
- 8. [Appendix](#)
- 9. [Specifications](#)
- 10. [Trademarks](#)
- 11. [Dimensional Drawings](#)

Press "Down" key -> Canadian English Ratings
-> Press "Enter" key and select one items as below

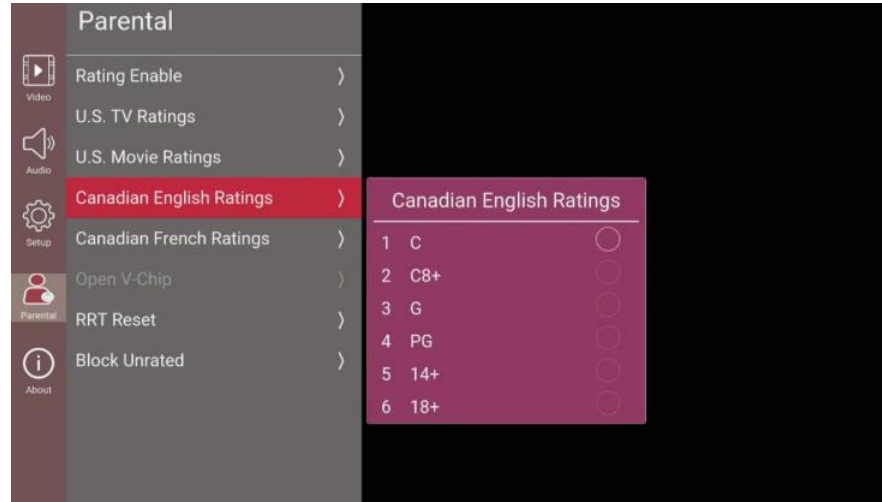

Press "Down" key -> Canadian French Ratings
-> Press "Enter" key and select one items as below

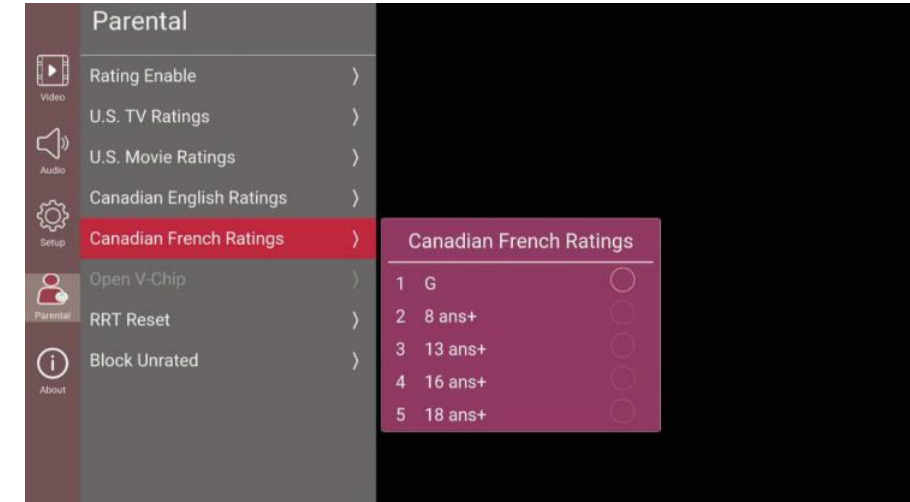

Press "Down" key -> Open V Chip -> Press "Enter" key and select one item as show below

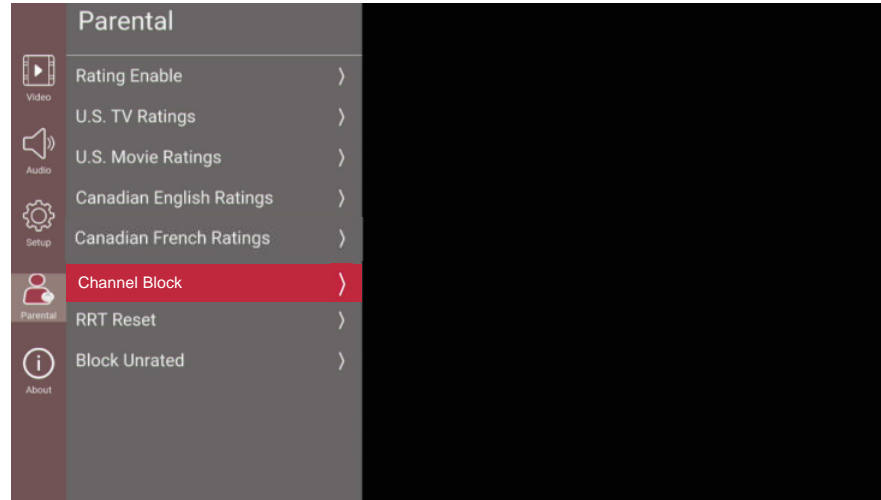

- 1. [Part Names](#)
- 2. [Introduction](#)
- 3. [Direct Button Operation](#)
- 4. [On-Screen Display Menu](#)
 - 1. [Introduction](#)
 - 2. [Menu Operation Buttons](#)
 - 3. [Video / Audio Settings](#)
 - 4. [Setup](#)
 - 5. [Parental Control](#)
- 5. [Application](#)
- 6. [Using a PC](#)
- 7. [Using the touch function](#)
- 8. [Appendix](#)
- 9. [Specifications](#)
- 10. [Trademarks](#)
- 11. [Dimensional Drawings](#)

- 1. [Part Names](#)
- 2. [Introduction](#)
- 3. [Direct Button Operation](#)
- 4. [On-Screen Display Menu](#)
 - 1. [Introduction](#)
 - 2. [Menu Operation Buttons](#)
 - 3. [Video / Audio Settings](#)
 - 4. [Setup](#)
 - 5. [Parental Control](#)
- 5. [Application](#)
- 6. [Using a PC](#)
- 7. [Using the touch function](#)
- 8. [Appendix](#)
- 9. [Specifications](#)
- 10. [Trademarks](#)
- 11. [Dimensional Drawings](#)

>> On-Screen Display Menu

<< Parental (Continue)

Press "Down" key to Block Unrated.

This function will block all the programs which it has no parental rating info.

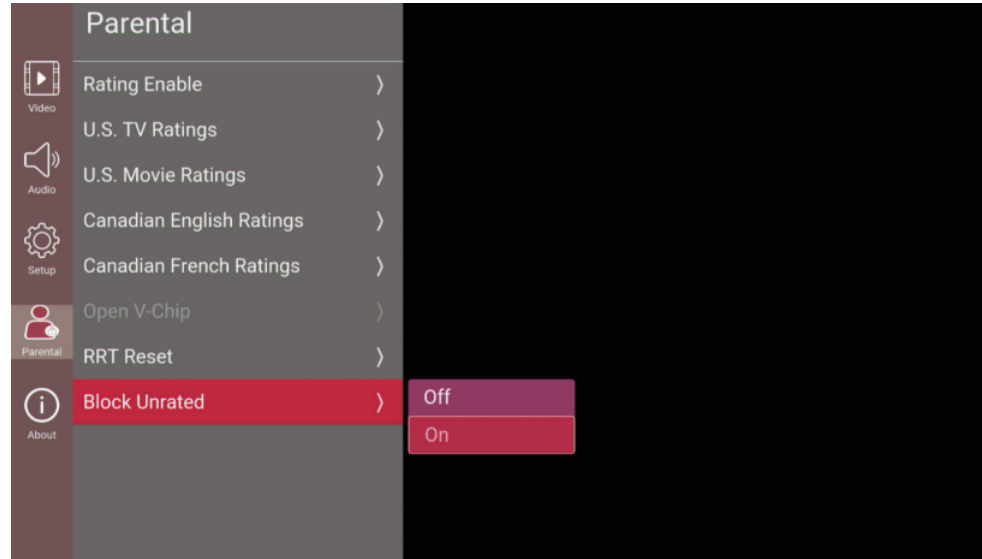

Press "ENTER" key to Turn OFF/ON Block Unrated option.

- 1. [Part Names](#)
- 2. [Introduction](#)
- 3. [Direct Button Operation](#)
- 4. [On-Screen Display Menu](#)
 - 1. [Introduction](#)
 - 2. [Menu Operation Buttons](#)
 - 3. [Video / Audio Settings](#)
 - 4. [Setup](#)
 - 5. [Parental Control](#)
- 5. [Application](#)
- 6. [Using a PC](#)
- 7. [Using the touch function](#)
- 8. [Appendix](#)
- 9. [Specifications](#)
- 10. [Trademarks](#)
- 11. [Dimensional Drawings](#)

Input Block

Select menu Input Blocked.

Press key 'up/down' to select the source --> press key 'OK' to block/unblock.

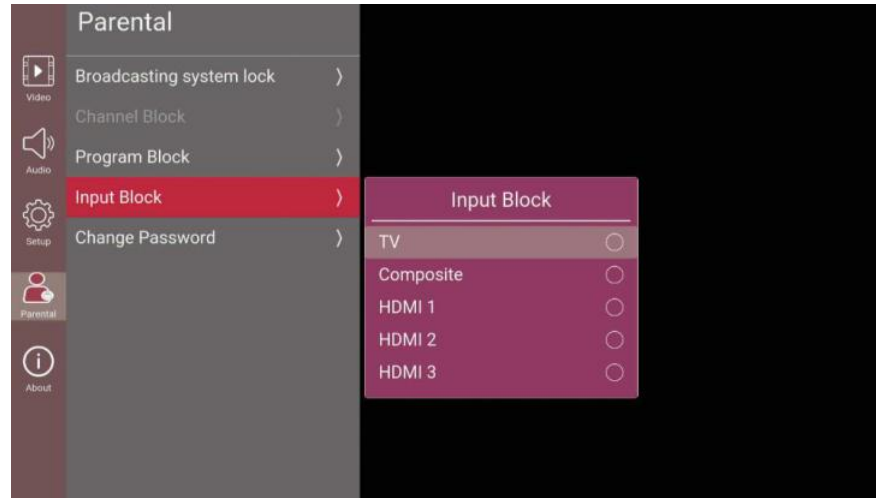

If you select a locked Input, it will appear Blocked, you must enter a password to enable the input.
If you don't enter a password, after a while it will show Input locked.

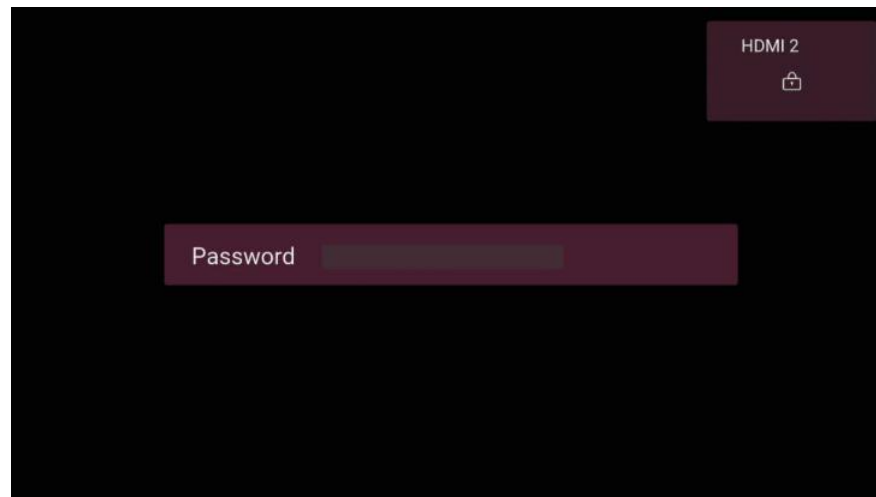

- 1. [Part Names](#)
- 2. [Introduction](#)
- 3. [Direct Button Operation](#)
- 4. [On-Screen Display Menu](#)
 - 1. [Introduction](#)
 - 2. [Menu Operation Buttons](#)
 - 3. [Video / Audio Settings](#)
 - 4. [Setup](#)
 - 5. [Parental Control](#)
- 5. [Application](#)
- 6. [Using a PC](#)
- 7. [Using the touch function](#)
- 8. [Appendix](#)
- 9. [Specifications](#)
- 10. [Trademarks](#)
- 11. [Dimensional Drawings](#)

Password Dialog (Change Password)

If current program has been blocked (channel block/ratings block/input) password dialog will be displayed on screen.

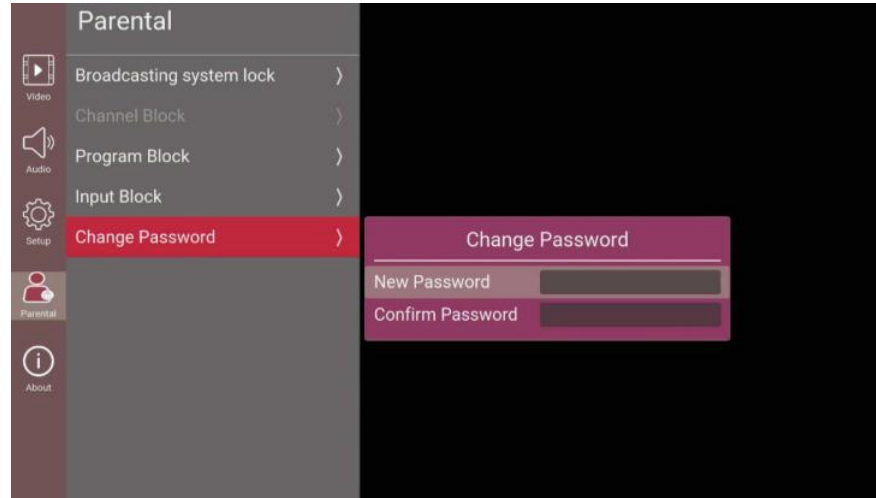

* Password is set "1234" as default.

- 1. [Part Names](#)
- 2. [Introduction](#)
- 3. [Direct Button Operation](#)
- 4. [On-Screen Display Menu](#)
 - 1. [Introduction](#)
 - 2. [Menu Operation Buttons](#)
 - 3. [Video / Audio Settings](#)
 - 4. [Setup](#)
 - 5. [Parental Control](#)
- 5. [Application](#)
- 6. [Using a PC](#)
- 7. [Using the touch function](#)
- 8. [Appendix](#)
- 9. [Specifications](#)
- 10. [Trademarks](#)
- 11. [Dimensional Drawings](#)

>> **On-Screen Display Menu**

<< **About**

The about interface mainly displays information, including Version Info, License Info, System Information and TV Name.

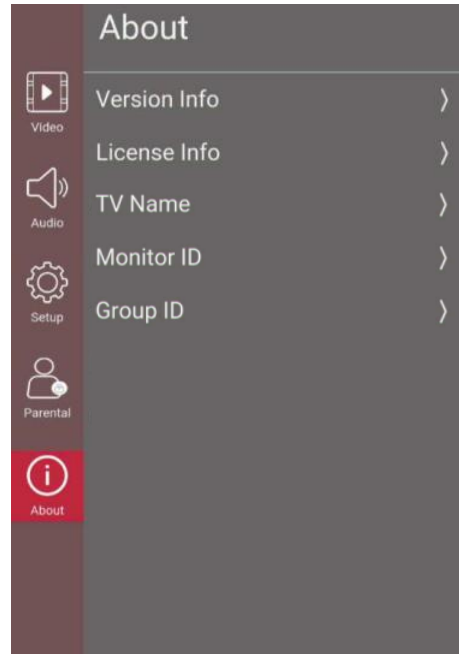

Selected item	
Version Info	Show Model Name, Version, Serial Number and Website.
License Info	Show the Information of "Data Collection and Firmware Updates Notice". Enter "View Additional Details" will display the Details.
TV name	Displays the name of the TV. It can be edited.
Monitor ID	Show the TV Name (a custom name for the display). It can be edited.
Group ID	Show the Group ID that the display is subordinated. It can be edited.

- 1. [Part Names](#)
- 2. [Introduction](#)
- 3. [Direct Button Operation](#)
- 4. [On-Screen Display Menu](#)
- 5. [Application](#)
 - 1. [MMP \(Multi Media Player\)](#)
 - 2. [Casting](#)
 - 3. [OPEN BROWSER](#)
- 6. [Using a PC](#)
- 7. [Using the touch function](#)
- 8. [Appendix](#)
- 9. [Specifications](#)
- 10. [Trademarks](#)
- 11. [Dimensional Drawings](#)

>> Application

<< MMP (Multi-Media Player)

Multimedia Player is a Media player application. Users can use it to enjoy video, photo, audio on TV.

How to launch MMP:

a: Press [INPUT] or b: Press [APPS] -> Select "MMP".

Enter MMP, MMP's main screen contains three multimedia type icons: Video, Photo and Audio.

Select one of the icons (Photo, Music or Video) and it will enter the corresponding file list screen.

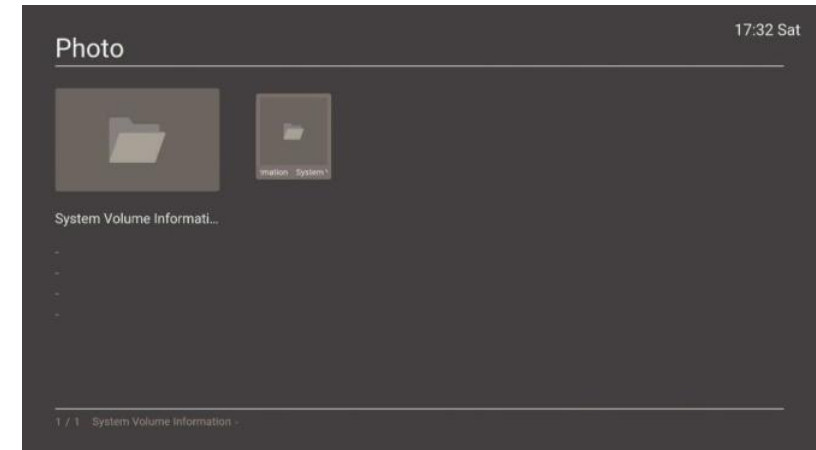
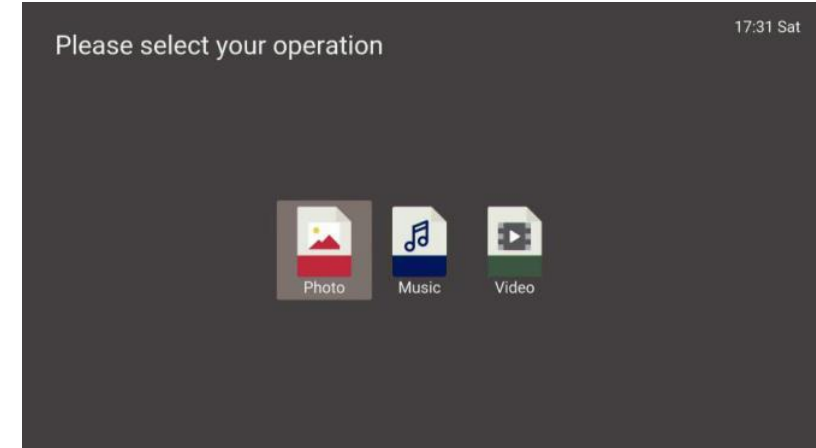

1. [Part Names](#)
2. [Introduction](#)
3. [Direct Button Operation](#)
4. [On-Screen Display Menu](#)
5. [Application](#)
 1. [MMP \(Multi Media Player\)](#)
 2. [Casting](#)
 3. [OPEN BROWSER](#)
6. [Using a PC](#)
7. [Using the touch function](#)
8. [Appendix](#)
9. [Specifications](#)
10. [Trademarks](#)
11. [Dimensional Drawings](#)



Video Playback

Select Video icon, enter video file list screen.

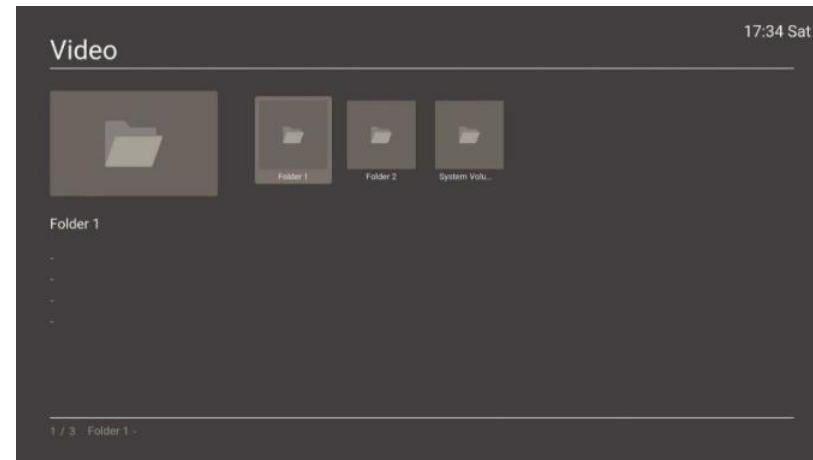
Grid mode:

All folders and supported videos of the current directory will be displayed.

The video file will display as a thumbnails.

- The video preview interface is displayed on the left side of the screen, where detailed video information is displayed, and you do not perform any operation on any video you select about 10s, the video will be automatically played in the small window on the left.
- Press "Left/Right/Up/Down" key to choose target file or folder.
- Press "Enter" key to play video or enter folder.
- Default is grid mode. To switch to list mode, press the "Blue" key.

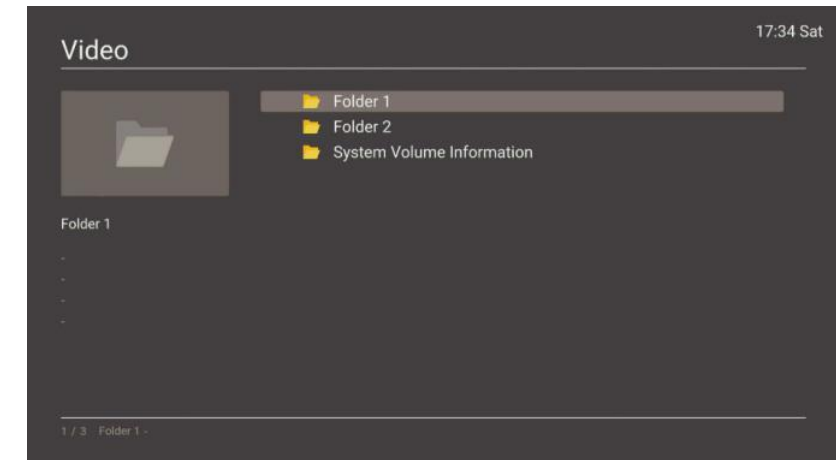
List mode:

In list mode, video does not display as a thumbnail.

- Press "Up/Down" key to choose target file or folder.
- When moving to a video file, the video will be played in the upper left corner.
- "Switch to grid mode by pressing the "Blue" key.

1.	Part Names
2.	Introduction
3.	Direct Button Operation
4.	On-Screen Display Menu
5.	Application
1.	MMP (Multi Media Player)
2.	Casting
3.	OPEN BROWSER
6.	Using a PC
7.	Using the touch function
8.	Appendix
9.	Specifications
10.	Trademarks
11.	Dimensional Drawings

>> Application

<< MMP (Multi-Media Player)

Video Playback

Media Supported format:

Video Codec

VP9	HEVC/H.265	MPEG1/2	MPEG4	DivX 3.11/DivX 4.12 DivX 5.x/DivX 6/XviD
Sorenson H.263	H.263	H.264	AVS	AVS+
AVS2	WMV3	VC1	Motion JPEG	VP8
RV30/RV40	AV1			

Audio Codec

MPEG1/2 Layer1	MPEG1/2 Layer2	MPEG1/2/2.5 Layer3	AC3(DD)	EAC3(DDP)
AAC-LC HEAAC	WMA	WMA 10 Pro M0	WMA 10 Pro M1	WMA 10 Pro M2
VORBIS	DTS	DTS LBR	DTS XLL	DTS Master Audio
LPCM	IMA-ADPCM MS-ADPCM	G711 A/mu-law	LBR (cook)	FLAC
OPUS	AC4	Fraunhofer MPEG-H TV Audio System	AMR-NB	AMR-WB

Photo Codec

JPEG	PNG	BMP
------	-----	-----

* jpeg image : In case of progressive jpeg, it is available only up to Full HD (1,920x1,080) resolution.



* PNG image : It does not support interlaced format .

File list menu:

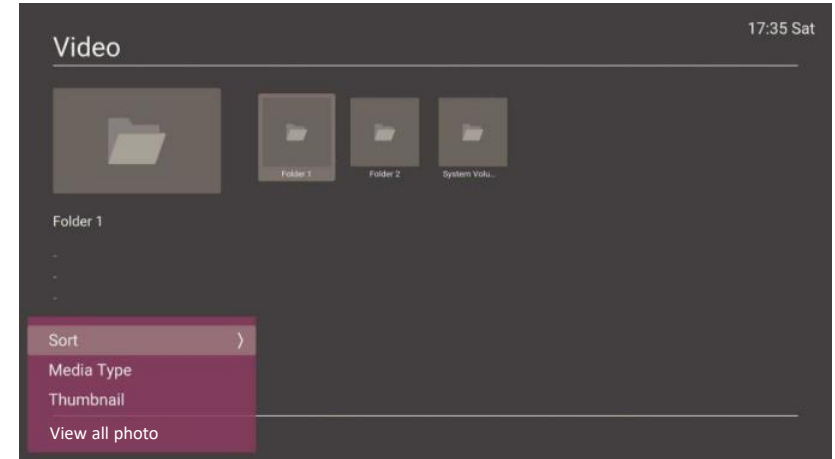
Press “Menu” key enter file list menu:
 *File list menu of Photo/Music is as same as Video.

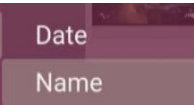

Note:
 No “Thumbnail” item in list mode menu.

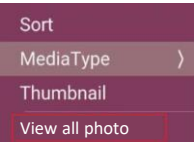
Item	Sub Item	Description
Sort	Date/Name 	Files sorting methods, modification by name or modification date.
Media type	Photo/Music/Video 	Enter the corresponding file list screen.
Thumbnail	Small/Medium/Large 	Change the size of folder icon and video thumbnail.
View all photo	View all photo USB directory 	a. “View all photo” will show all videos in the current device. b. “USB directory” is the default mode, will show all folders and supported videos in the current directory.

- You can launch Casting by pressing “APPS” on remote control -> select “Casting” and press ENTER.
- You can cast the screen from your device to the TV.

1. Launch “Casting” from “APPS”.

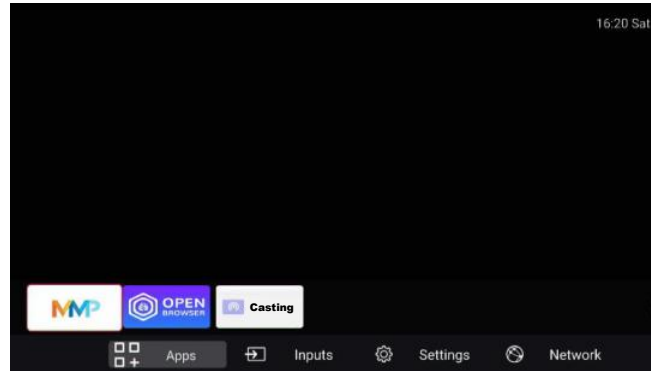

- * See client device for further instructions.
- 2. Find this display and start casting.

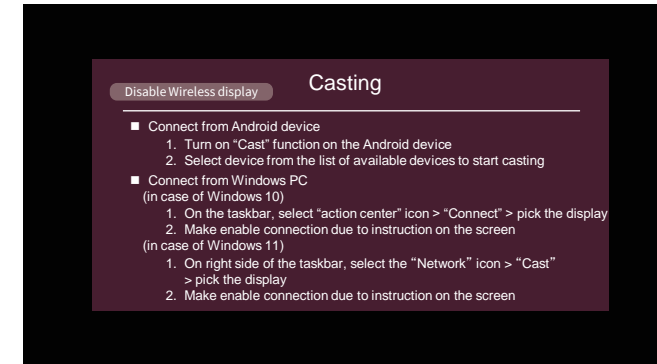

1. Part Names
2. Introduction
3. Direct Button Operation
4. On-Screen Display Menu
5. Application
 1. MMP (Multi Media Player)
 2. Casting
 3. OPEN BROWSER
6. Using a PC
7. Using the touch function
8. Appendix
9. Specifications
10. Trademarks
11. Dimensional Drawings

Requirement of client devices

Device	Requirement
Android	Android 9 or later
Windows	Windows 10 or later Wireless LAN is mandatory Processor: 1GHz or faster RAM: 2GB is mandatory, 8GB is recommend

Specification

Wireless LAN: uses 2.4GHz bandwidth (5GHz does not support)
 Max resolution on the display : Full HD(1,920 x 1,080)
 Support OS : Android and Windows
 Apple devices and Chrome OS are not supported
 Video / Sound quality depends on network environment.
 Not all devices are compatible with this casting app.

1. Part Names

2. Introduction

3. Direct Button Operation

4. On-Screen Display Menu

5. Application

1. MMP (Multi Media Player)

2. Casting

3. OPEN BROWSER

6. Using a PC

7. Using the touch function

8. Appendix

9. Specifications

10. Trademarks

11. Dimensional Drawings



Application (Using the Internet)



OPEN BROWSER

Connecting to the Internet

By connecting your TV to a broadband system, you can access the Internet from the TV.

To connect your TV to the Internet, you must have a broadband Internet connection.

If you do not have a broadband Internet connection, consult the store where you purchased your TV or ask your Internet service provider or telephone company.

When an Internet connection is made, an Ethernet and wireless connection cannot be used at the same time. Use only one of the connection types.

Using an ETHERNET cable

Use an ETHERNET cable (commercially available) to connect the ETHERNET terminal on the TV to your broadband router (commercially available).

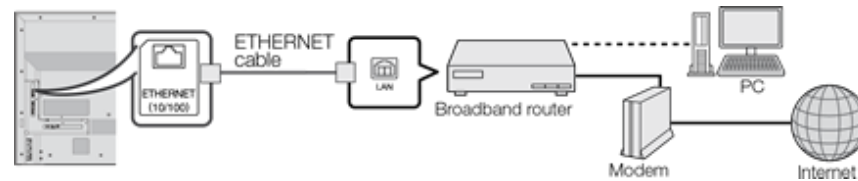

Using the wireless LAN

This TV is equipped with a wireless LAN function.

For a wireless LAN connection, you must use "Wireless Setup" to connect the access point and TV.



Network Settings

Perform the procedure below to make adjustments or to confirm the settings for accessing the Internet.

1. Press MENU to display the MENU screen, and then press ENTER.
2. Press ◀/▶ to select "Network Setting", and then press ENTER.
3. Press ▲/▼ to select "Connection Type", and then press ENTER.
Press ▲/▼ select "Wired" or "Wireless". and press ENTER.
4. Press ▲/▼ to select "Wired Setup", or "Wireless Setup", and then press ENTER.
Select "Wired Setup" when you make general adjustments to connect to the Internet.
5. Press MENU to exit.

NOTE

- This TV has a built-in wireless LAN function. Using a separate wireless USB LAN adapter may result in radio communications that do not comply with regulations on radio communications. Therefore, do not use a separate wireless LAN.
- A wireless LAN connection and performance cannot be guaranteed for all residential environments. In the following cases, the wireless LAN signal may be poor or drop, or the connection speed may become slower.
 - When used in buildings made with concrete, reinforced steel, or metal.
 - When placed near objects that obstruct the signal.
 - When used with other wireless devices that emit the same frequency.
 - When used in the vicinity of microwave ovens and other devices that emit a magnetic field, electrostatic charge, or electromagnetic interference.

- To launch Web-browser press “APPS” on remote control -> select “OPEN BROWSER” and press ENTER.
- Go to the Browser homepage. You may see there are some apps to choose.

Press the Settings icon in the upper right corner of the screen to enter the Settings page.

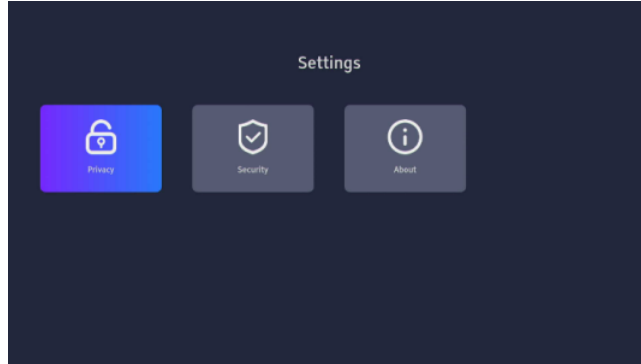

Bookmarks: Saved favorite pages.

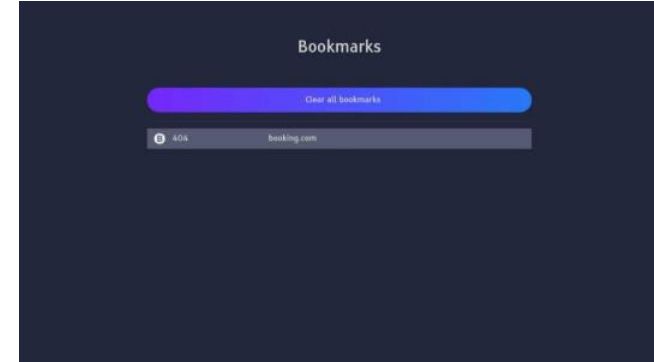

History: View previously visited pages.

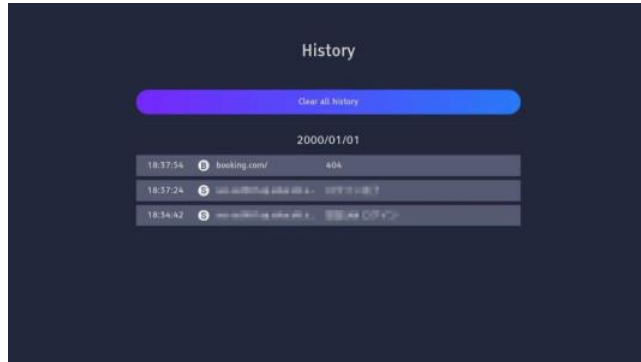

Privacy: Clear cached data.



1. Part Names
2. Introduction
3. Direct Button Operation
4. On-Screen Display Menu
5. Application
 1. MMP (Multi Media Player)
 2. Casting
 3. OPEN BROWSER
6. Using a PC
7. Using the touch function
8. Appendix
9. Specifications
10. Trademarks
11. Dimensional Drawings

- 1. [Part Names](#)
- 2. [Introduction](#)
- 3. [Direct Button Operation](#)
- 4. [On-Screen Display Menu](#)
- 5. [Application](#)
 - 1. [MMP \(Multi Media Player\)](#)
 - 2. [Casting](#)
 - 3. [OPEN BROWSER](#)
- 6. [Using a PC](#)
- 7. [Using the touch function](#)
- 8. [Appendix](#)
- 9. [Specifications](#)
- 10. [Trademarks](#)
- 11. [Dimensional Drawings](#)

>> Application (Using the Internet)

<< OPEN BROWSER

- To launch Web-browser press “APPS” on remote control -> select “OPEN BROWSER” and press ENTER.
- Go to the Browser homepage. You may see there are some apps to choose.

Security: Can be set to disabled ads and web pages.



The keyboard will display when you select the search bar. Use the keyboard to search.

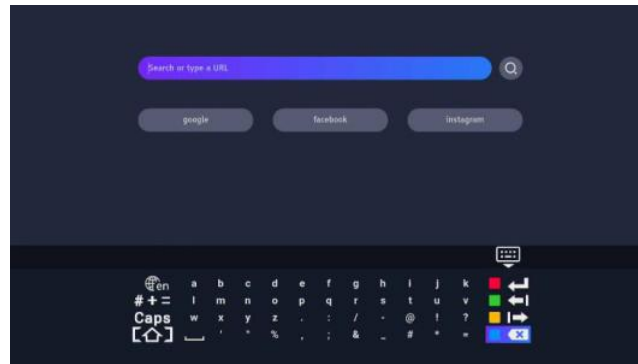

About: You can see the Cookies Policy, Terms of Use and Privacy Policy.

Click to enter to view detailed information.

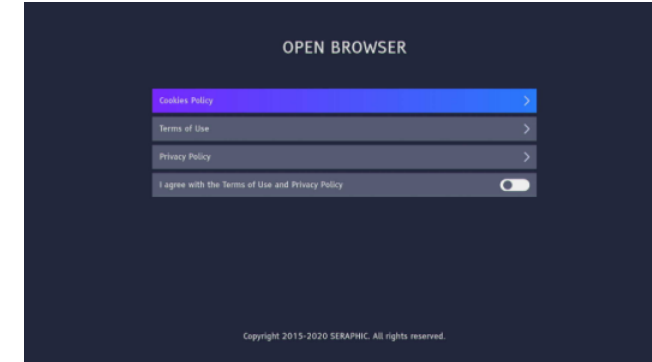

NOTE

The web browser application may not reproduce onscreen content accurately as seen with a computer web browser. Please confirm any visual signage media on the browser.

1.	Part Names
2.	Introduction
3.	Direct Button Operation
4.	On-Screen Display Menu
5.	Application
6.	Using a PC
1.	Control of the TV
2.	PC Compatibility Chart/AV Compatibility Chart
7.	Using the touch function
8.	Appendix
9.	Specifications
10.	Trademarks
11.	Dimensional Drawings



The TV can be controlled from a PC, control panels and other devices using RS-232C or IP. Use a cross-type RS-232C cable. (Needs the conversion cable to minijack (Terminal : "RS-232C") for using RS-232C.) ETHERNET cable (commercially available) or wireless LAN for the connections

NOTE

- The Power on function is available only with the RS-232C connection at 9600 baud.
- Use a Wake On LAN function when using IP connection.
- When the TV is powered off via RS232C, please wait approx. 30 seconds before sending the power on command.

IP Control

Set this function when operating the TV from equipment connected by LAN. To perform the operation, refer to "Network Settings".

IP Control

When "IP Control" is selected, "Change" will be highlighted. Press ENTER.

Detailed Settings

Make the detailed settings (Login ID, password, etc.).

Follow the on-screen instructions to configure these settings.

Device Name

Set the name of the TV displayed on other network devices.

- Use the software keyboard to set the name.

1.	Part Names
2.	Introduction
3.	Direct Button Operation
4.	On-Screen Display Menu
5.	Application
6.	Using a PC
1.	Control of the TV
2.	PC Compatibility Chart/AV Compatibility Chart
7.	Using the touch function
8.	Appendix
9.	Specifications
10.	Trademarks
11.	Dimensional Drawings



Communication Conditions for IP

Connect to the TV with the following settings made for IP on the PC.

IP protocol:	TCP/IP
Host IP address:	Set the IP address on the TV menu
Service:	None (Do not select Telnet or SSH)
TCP port#:	Set a port number on the TV menu (Control port)

When you set your ID and password on the TV menu, you need to enter them as soon as you connect to the TV.

NOTE

- To use this function, select settings of "IP Control".
- The connection will be cut off when there has been no communication for 3 minutes.

Communication Conditions for RS-232C

Set the RS-232C communication settings on the PC to match the Monitor's communication conditions.

The Monitor's communication settings are as follows:

Baud rate:	9,600 / 115,200 baud
Data length:	8 bits
Parity bit:	None
Stop bit:	1 bit

Communication procedure.

Send the control commands from the PC via the RS-232C or IP. The TV operates according to the received command and sends a response message to the PC.

Do not send multiple commands at the same time.

Wait until the PC receives the OK response before sending the next command.

- 1. Part Names
- 2. Introduction
- 3. Direct Button Operation
- 4. On-Screen Display Menu
- 5. Application
- 6. Using a PC
 - 1. Control of the TV
 - 2. PC Compatibility Chart/AV Compatibility Chart
- 7. Using the touch function
- 8. Appendix
- 9. Specifications
- 10. Trademarks
- 11. Dimensional Drawings

Communication conditions

Set the RS-232C communication settings on the computer to match the monitor's communication settings as follows:

Baud rate	9600bps	Stop bit	1 bit
Data length	8 bits	Flow control	None
Parity bit	None		

Communication procedure

● Command format

When a command is sent from the computer to the monitor, the monitor operates according to the received command and sends a response message to the computer.

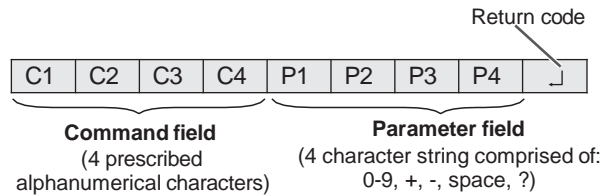

Example: VOLM0030
VOLM □ □ 30

- * Be sure to input 4 characters for the parameter. Pad with spaces ("□") if necessary.
("□" is a return code (0DH, 0AH or 0DH)) Wrong : VOLM30 □
Right : VOLM □ □ 30□

The current value can be returned by using "?" as the parameter.

Example:

VOLM ? ← From computer to monitor (How much is current volume setting?).

30 ← From monitor to computer (Current volume setting: 30).

● Response code format

When a command has been executed correctly

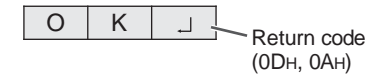

A response is returned after a command is executed.

When a command has not been executed

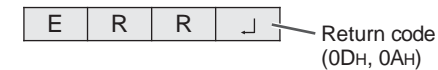

TIPS

- "ERR" is returned when there is no relevant command or when the command cannot be used in the current state of the monitor.
- If communication has not been established for reasons such as a bad connection between the computer and monitor, nothing is returned (not even ERR).
- "ERR" may be returned when a command cannot be received correctly due to interference from the surrounding environment.
Please ensure that the system or software resends the command if this occurs.

● Communication interval

- After OK or ERR is returned, you must send the following commands.
- To set a timeout for the command response, specify 10 seconds or longer.
- Provide an interval of 100 ms or more between the command response and the transmission of the next command.



- 1. Part Names
- 2. Introduction
- 3. Direct Button Operation
- 4. On-Screen Display Menu
- 5. Application
- 6. Using a PC
 - 1. Control of the TV
 - 2. PC Compatibility Chart/AV Compatibility Chart
- 7. Using the touch function
- 8. Appendix
- 9. Specifications
- 10. Trademarks
- 11. Dimensional Drawings

Command table

How to read the command table

- Command: Command field
- Direction: W When the "Parameter" is set in the parameter field, the command functions as described under "Control/Response Contents".
R The returned value indicated under "Reply" can be obtained by setting "???" or " _ _ _ ?" in the parameter field.

Power control/Input mode selection

Function	Command	Direction	Parameter	Reply	Control Response content	Remarks
POWER CONTROL	POWR	W	0		Switch to standby mode	<ul style="list-style-type: none"> • Power on function is available only in RS-232C connection with 9600 baud. • Use WoL function when using IP connection. • When the TV is powered off via RS232C, please wait approx. 30 seconds before sending the power on command.
			1		Return from standby mode	
		R		1	Normal mode	
INPUT MODE SELECTION	INPS	WR	0~6	0~6	TV = 0 HDMI1 = 2 USB = 5 AV = 1 HDMI2 = 3 HOME = 6 HDMI3 = 4	

Picture menu

Function	Command	Direction	Parameter	Reply	Control Response content	Remarks
BRIGHT	VLMP	WR	1~100	1~100		
COLOR MODE	BMOD	WR	0~10	0~10	7 : Standard 3 : Dynamic 9 : Movie 4 : Dynamic(Fixed) 10 : Game 0 : User 2 : PC	
SIZE	WIDE	WR	1~7	1~7	1 : Auto 5 : 4:3 2 : Normal 6 : 14:9 3 : Zoom 7 : 16:9 4 : Dot by Dot 8 : Letterbox 9 : Panorama	In each case, display mode will be changed to "normal" when video source has changed and unable to adopt current display mode.

Others menu

Function	Command	Direction	Parameter	Reply	Control Response content	Remarks
VOLUME	VOLM	WR	1~100	1~100		
MUTE AUDIO	MUTE	WR	0-1	0-1	0 MUTE_OFF 1 MUTE_ON	
MODEL	INF1	R				
SERIAL NO	SRNO	R				
Usage Time	UTIM	WR				
MAIN firmware version	FMVR	R				
MAC address	RMAC	R				
RESET	RSET	W				

1. Part Names
2. Introduction
3. Direct Button Operation
4. On-Screen Display Menu
5. Application
6. Using a PC
1. Control of the TV
2. PC Compatibility Chart/AV Compatibility Chart
7. Using the touch function
8. Appendix
9. Specifications
10. Trademarks
11. Dimensional Drawings

**NOTE**

- When you use a network, your communication data is exposed to the risks of being stolen or illegally accessed. To avoid these risks, you need to use this monitor in a secure network environment.

NOTE

- When POWER SAVE MODE is set to ON, the control is disabled in the standby mode/input signal waiting state.
- To control the monitor via LAN, set RS-232C/LAN SELECT to LAN.
- You cannot use RS-232C and LAN control simultaneously.

● To set on the monitor

Set RS-232C/LAN SELECT of COMMUNICATION SETTING on the SETUP menu to LAN, and then set the LAN SETUP options. After setting each item, select SET and press the ENTER button.

VIEW NETWORK SETTINGS

Displays LAN setting information.

DHCP CLIENT

If your LAN has a DHCP server and you wish to obtain an address automatically, change this setting to ON. To set the address manually, set this to OFF.

IP ADDRESS

If the DHCP CLIENT is set to OFF, specify an IP address. Press the ◀ or ▶ button to select the items, and enter the values with the numeric input buttons (0 to 9).

You can also change the values with the ▲ or ▼ button.

SUBNET MASK

If the DHCP CLIENT is set to OFF, specify the subnet mask. Press the ◀ or ▶ button to select the items, and enter the values with the numeric input buttons (0 to 9).

You can also change the values with the ▲ or ▼ button.

Command-based control

You can control the monitor using RS-232C commands via terminal software and other appropriate applications. Read the manual for the terminal software for detailed instructions.

(1) Connect the computer to the monitor.

1. Specify the IP address and data port number (10008) and connect the computer to the monitor. When connection has been established successfully, [Login:] is returned as response.
2. Send the user name.
 - Send [user name] + [□].
 - If the user name is not set, send [□].
 - When the transmission is successful, [□ Password:] is returned as response.
3. Send the password.
 - Send [password] + [□].
 - If the password is not set, send [□]. [□ New password:] is returned as response. Please set a password. Send [password] + [□]. [□ Retype new password:] is returned as response. Send [password] + [□] again.
 - When the transmission is successful, [OK □] is returned as response.

(2) Send commands to control the monitor.

- The commands used are the same as those for RS-232C. Refer to the communication procedure for operation.
- Usable commands are provided in the RS-232C command table.

(2) Disconnect the connection with the monitor and quit the function.

1. Send [BYE □]. When the transmission is successful, [goodbye] is returned and the connection is disconnected.



- 1. Part Names
- 2. Introduction
- 3. Direct Button Operation
- 4. On-Screen Display Menu
- 5. Application
- 6. Using a PC
 - 1. Control of the TV
 - 2. PC Compatibility Chart/AV Compatibility Chart
- 7. Using the touch function
- 8. Appendix
- 9. Specifications
- 10. Trademarks
- 11. Dimensional Drawings

It is necessary to set the PC correctly to display XGA and WXGA signal.

Resolution		Horizontal Frequency	Vertical Frequency	VESA Standard
VGA	720 x 400	31.5 kHz	70 Hz	-
	640 x 480	31.5 kHz	60 Hz	Yes
		37.9 kHz	72 Hz	Yes
		37.5 kHz	75 Hz	Yes
SVGA	800 x 600	35.1 kHz	56 Hz	Yes
		37.9 kHz	60 Hz	Yes
		48.1 kHz	72 Hz	Yes
		46.9 kHz	75 Hz	Yes
XGA	1024 x 768	48.4 kHz	60 Hz	Yes
		56.5 kHz	70 Hz	Yes
		60.0 kHz	75 Hz	Yes
WXGA	1360 x 768	47.7 kHz	60 Hz	Yes
SXGA	1280 x 1024	64.0 kHz	60 Hz	Yes
SXGA+	1400 x 1050	65.3 kHz	60 Hz	Yes
1080p	1920 x 1080	67.5 kHz	60 Hz	-
UHD	3840 x 2160	112.5 kHz	50 Hz	-
		135 kHz	60 Hz	-

VGA and XGA are registered trademarks of International Business Machines Corp.

Resolution	Vertical Frequency	HDMI
640 x 480p	59.94 Hz	Yes
	60 Hz	Yes
720 x 480p	59.94 Hz	Yes
	60 Hz	Yes
720 x 576p	50 Hz	Yes
720(1440) x 480i	59.94 Hz	Yes
	60 Hz	Yes
720(1440) x 576i	50 Hz	Yes
1280 x 720p	50 Hz	Yes
	59.94 Hz	Yes
	60 Hz	Yes
1920 x 1080i	50 Hz	Yes
	59.94 Hz	Yes
	60 Hz	Yes
1920 x 1080p	24 Hz	Yes
	50 Hz	Yes
	59.94 Hz	Yes
	60 Hz	Yes
3840 x 2160p	30 Hz	Yes
	60 Hz	Yes

- 1. Part Names
- 2. Introduction
- 3. Direct Button Operation
- 4. On-Screen Display Menu
- 5. Application
- 6. Using a PC
- 7. Using the touch function (Only for touch models)
 - 1. Computer connection
 - 2. Touch actions
- 8. Appendix
- 9. Specifications
- 10. Trademarks
- 11. Dimensional Drawings

• **HDMI input 1, 2 or 3**

Use a commercially available HDMI cable (conforming to the HDMI standard) that supports 4K.

• **TOUCH PANEL terminal**

Connect only with supplied USB cable and adapter depending on type of USB on a computer. The terminal on the monitor is a USB Type-C connector.

- Use the USB cable (supplied) to connect to a computer with USB Type A port.

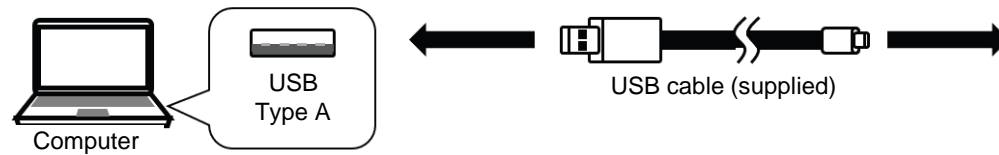

- Use the USB cable (supplied) and the USB A to C adapter (supplied) to connect to a computer with USB Type C port.

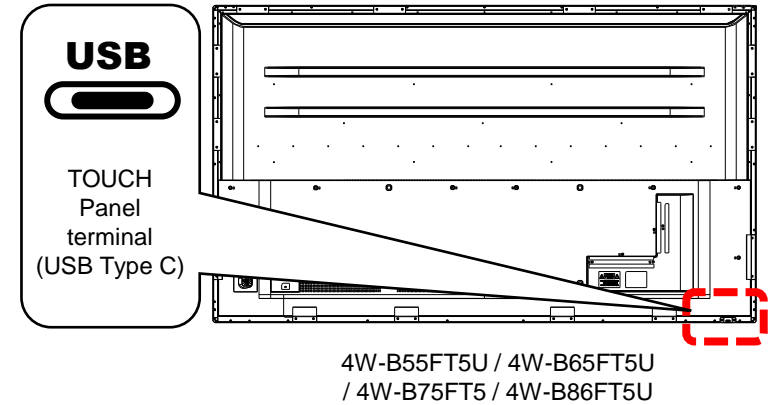
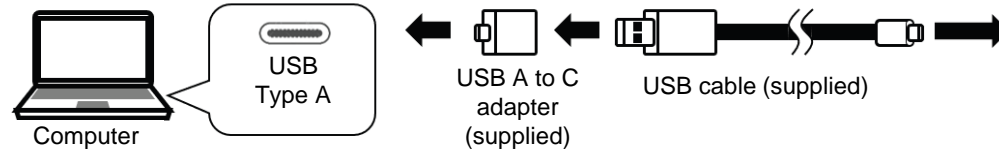

NOTE

- Please only use supplied USB cable and USB adaptor to connect with computers. Using other commercially available USB type C cables may not support touch functions and can damage the product.

- 1. [Part Names](#)
- 2. [Introduction](#)
- 3. [Direct Button Operation](#)
- 4. [On-Screen Display Menu](#)
- 5. [Application](#)
- 6. [Using a PC](#)
- 7. [Using the touch function \(Only for touch models\)](#)
 - 1. [Computer connection](#)
 - 2. [Touch actions](#)
- 8. [Appendix](#)
- 9. [Specifications](#)
- 10. [Trademarks](#)
- 11. [Dimensional Drawings](#)

• **Touch action**

Touch actions that can be used with this display differ according to operating system and application. The functions of touch actions are also different. For the details, check the operating system’s help and the application’s support documentation.

Operating system		Windows 10 / 11	Chrome OS
Touch action	Single-tap	Yes	Yes
	Double-tap	Yes	Yes
	Swipe	Yes	Yes
	Swipe from edge of screen	Yes	Yes
	Drag-and-drop	Yes	Yes
	Flicks	Yes	Yes
	Press-and-hold	Yes	Yes
	Slide to pan	Yes	Yes
	Zoom	Yes	Yes
	Press-and-tap	No	Yes
	Rotate	Yes	Yes

TIPS

- On the mac, the actions are the equivalent mouse actions.

CAUTION

- Using touch function of 4W-B55 / 65 / 75 / 86FT5U for any on-screen display menu settings is not supported.

• **Common finger and touch pen actions**

Connect only with supplied USB cable and adapter depending on type of USB on a computer. The terminal on the monitor is a USB Type-C connector.

Single-tap

Same action as left-clicking a mouse. Touch with your finger/touch pen.



Double-tap

Same action as double-clicking a mouse. Quickly touch twice with your finger/touch pen.

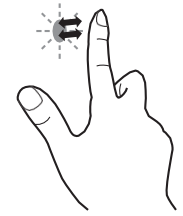

Swipe

Touch the screen with your finger/touch pen, move without lifting, and then stop.



When double-tapping with your finger, be sure to lift your finger sufficiently off the screen after the first tap. If there is insufficient distance between the screen and your finger, double-tap will not take place.

1. [Part Names](#)
2. [Introduction](#)
3. [Direct Button Operation](#)
4. [On-Screen Display Menu](#)
5. [Application](#)
6. [Using a PC](#)
7. [Using the touch function \(Only for touch models\)](#)
 1. [Computer connection](#)
 2. [Touch actions](#)
8. [Appendix](#)
9. [Specifications](#)
10. [Trademarks](#)
11. [Dimensional Drawings](#)

**Swipe from edge of screen**

After touching the edge of the monitor with your finger/touch pen, move horizontally without releasing your finger/touch pen and then stop.

**Drag-and-drop**

Same action as drag-and-drop with a mouse. Touch the screen with your finger/touch pen and move without lifting. When you have finished the movement, lift your finger/ touch pen.

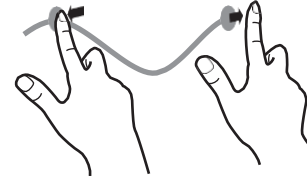
**Flicks**

Flick your finger/touch pen in the direction of the function you want to use.

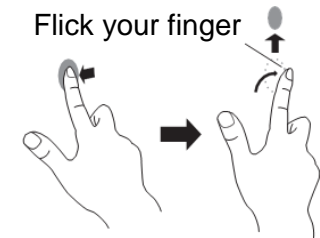
**Press-and-hold**

Same action as right-clicking a mouse. Press briefly with your finger/touch pen, and then lift your finger/touch pen from the screen.

**Slide to pan**

With your finger/touch pen touching the screen, move it up and down to scroll the screen.

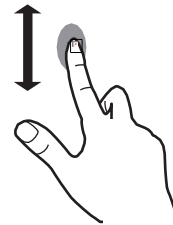
**Press-and-tap**

Same action as right-clicking a mouse. With one finger touching the screen, tap once (single tap) with another finger.

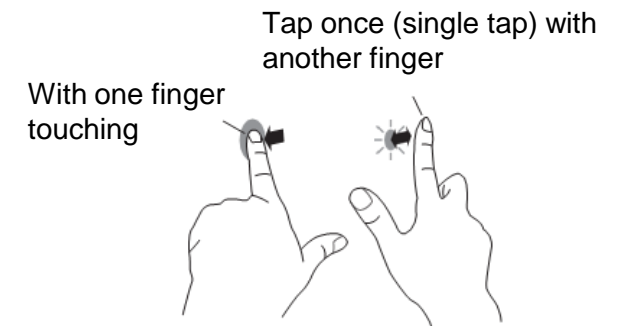

- 1. [Part Names](#)
- 2. [Introduction](#)
- 3. [Direct Button Operation](#)
- 4. [On-Screen Display Menu](#)
- 5. [Application](#)
- 6. [Using a PC](#)
- 7. [Using the touch function \(Only for touch models\)](#)
 - 1. [Computer connection](#)
 - 2. [Touch actions](#)
- 8. [Appendix](#)
- 9. [Specifications](#)
- 10. [Trademarks](#)
- 11. [Dimensional Drawings](#)

Zoom

Use in a screen that is capable of enlargement/reduction. Touch the screen with two fingers and move your fingers closer together to reduce the view, or apart to enlarge the view.

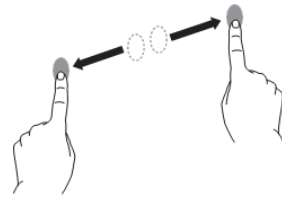

Reduction

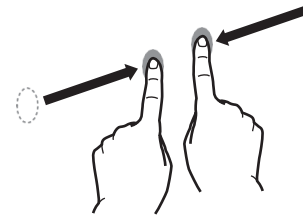

Enlargement

Rotate

Use this action in a screen that is capable of image rotation. Touch the center point of the rotation with one finger. While holding that finger still, move another finger in the desired direction of rotation.

Move another finger in the desired direction of rotation

With one finger touching

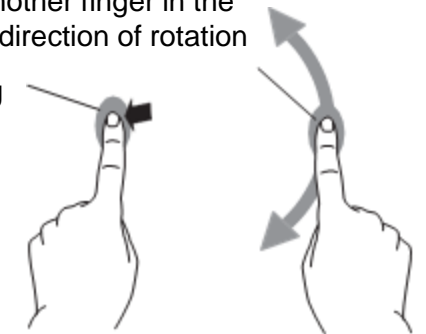

1. Part Names
2. Introduction
3. Direct Button Operation
4. On-Screen Display Menu
5. Application
6. Using a PC
7. Using the touch function
8. Appendix
1. Setting the TV on the Wall
2. Troubleshooting
9. Specifications
10. Trademarks
11. Dimensional Drawings

For 4P-B50EJ2U, 4P-B55EJ2U and 4P-B65EJ2U

- Screws which suits for each models are set in the box.
- Especially, 50", 55", 65" models are different length screws required for either upper side and lower side.
- Screws for each upper and lower side are packed to separate bags (50", 55", 65" models).
- Please take care length of screws.
 - Long length screws: for upper side
 - Short length screws: for lower side

For 4P-B75EJ2U

- Screw length are same for upper side and lower side.
- 4 pcs. of sleeves are set in the box. Please insert these to each VESA holes before fasten screws.

For 4P-B43EJ2U

- There are 2 screw holes on the display. Screw length are same.

For the screws, refer to the table shown below.

Unit mm

		4P-B43EJ2U	4P-B50 / 55 / 65EJ2U	4P-B75EJ2U	4P-B86EJ2U
Standard screws		M6 (1.0 pitch)	M6 (1.0 pitch)	M8 (1.25 pitch)	M8 (1.25 pitch)
Length (Depth of mounting holes)	Upper side	30 mm	33 mm	24 mm	30 mm
	Lower side	12 mm	10 mm		
Quantity		4 pcs.	4 pcs. (set in the box)	4 pcs.	

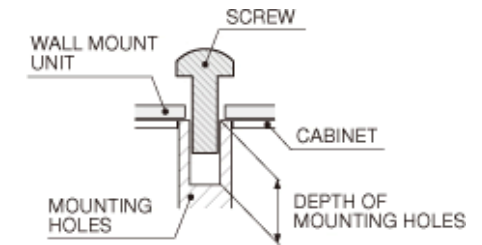

NOTE

- To use this TV mounted on a wall, remove the cable tie as needed.
- Do not use screws that do not comply with the VESA standard screw specifications.
- Do not use screws that are longer than the standard length. Screws that are too long may cause damage to the inside of the TV.
- Do not fasten the screws too firmly or loosely. This may damage the product or cause the product to fall, leading to personal injury. SHARP is not liable for these kinds of accidents.
- SHARP is not liable for product damage or personal injury when a non-VESA or non-specified wall mount is used, or the consumer fails to follow the product installation instructions.



Do not install the wall mount kit while your TV is turned on. It may result in personal injury due to electric shock.

- 1. Part Names
- 2. Introduction
- 3. Direct Button Operation
- 4. On-Screen Display Menu
- 5. Application
- 6. Using a PC
- 7. Using the touch function
- 8. Appendix
 - 1. Setting the TV on the Wall
 - 2. Troubleshooting
- 9. Specifications
- 10. Trademarks
- 11. Dimensional Drawings

For 4W-B55FT5U and 4W-B65FT5U

- Screws which suits for each models are set in the box.
- Especially, 55", 65" models are different length screws required for either upper side and lower side.
- Screws for each upper and lower side are packed to separate bags (55", 65" models).
 - Please take care length of screws.
 - Long length screws: for upper side
 - Short length screws: for lower side

For Rest of models

- Screw length is the same for upper side and lower side.
- 4 pcs. of sleeves are set in the box. Please insert these to each VESA holes before fasten screws.

For the screws, refer to the table shown below.

Unit mm

	4W-B55FT5U and 4W-B65FT5U		4W-B75FT5U	4W-B86FT5U
Standard screws	M6 (1.0 pitch)		M8 (1.25 pitch)	M8 (1.25 pitch)
Length(Depth of mounting holes)	Upper side	33 mm	24 mm	30 mm
	Lower side	10 mm		
Quantity	4 pcs. (set in the box)		4 pcs.	

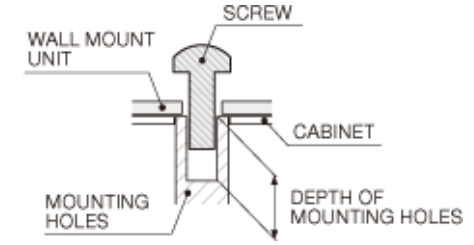

NOTE

- To use this TV mounted on a wall, remove the cable tie as needed.
- Do not use screws that do not comply with the VESA standard screw specifications.
- Do not use screws that are longer than the standard length. Screws that are too long may cause damage to the inside of the TV.
- Do not fasten the screws too firmly or loosely. This may damage the product or cause the product to fall, leading to personal injury. SHARP is not liable for these kinds of accidents.
- SHARP is not liable for product damage or personal injury when a non-VESA or non-specified wall mount is used, or the consumer fails to follow the product installation instructions.



Do not install the wall mount kit while your TV is turned on. It may result in personal injury due to electric shock.

1. Part Names
2. Introduction
3. Direct Button Operation
4. On-Screen Display Menu
5. Application
6. Using a PC
7. Using the touch function
8. Appendix
1. Setting the TV on the Wall
2. Troubleshooting
9. Specifications
10. Trademarks
11. Dimensional Drawings

Problem	Possible Solution
No power.	<ul style="list-style-type: none"> • Check if you pressed POWER on the remote control unit. • Is the AC cord disconnected? • Has the power been turned on?
Unit cannot be operated.	<ul style="list-style-type: none"> • External influences such as lightning, static electricity, may cause improper operation. In this case, operate the unit after first turning off the power of the TV or unplugging the AC cord and replugging it in after 1 or 2 minutes.
Remote control unit does not operate.	<ul style="list-style-type: none"> • Are batteries inserted with polarity (+, -) aligned? • Are batteries worn out? (Replace with new batteries). • Are you using it under strong or fluorescent lighting? • Is a fluorescent light illuminated near the remote control sensor?
Picture is cut off/with sidebar screen.	<ul style="list-style-type: none"> • Is the image position correct? • Are screen mode adjustments such as picture size made correctly?
Strange color, light color, or color misalignment	<ul style="list-style-type: none"> • Adjust the picture tone. • Is the room too bright? The picture may look dark in a room that is too bright.
Power is suddenly turned off.	<ul style="list-style-type: none"> • Is the sleep timer set? • Check the power control settings. • The unit's internal temperature has increased. Remove any objects blocking vent or clean.

Problem	Possible Solution
No picture.	<ul style="list-style-type: none"> • Is connection to other components correct? • Is the correct input selected? • If the PC image is not displayed, check the following: <ul style="list-style-type: none"> - When connecting a laptop PC to the TV, check that display output mode of the PC is set to external TV. - Check the resolution setting on the PC. Is a non-compatible signal being input?
Picture quality of HD videos is poor.	<ul style="list-style-type: none"> • To enjoy HD images from external equipment, you are required to set up HDMI connection or component connection. • If the Video source is not of HD quality, HD images cannot be displayed. Check that the Video source you are viewing provides HD images. • The HD cable/satellite set-top box may need to be configured to output HD images via cable/satellite.
The TV sometimes makes a cracking sound.	<ul style="list-style-type: none"> • This is not a malfunction. This happens when the cabinet slightly expands and contracts according to change in temperature. This does not affect the Monitor's performance.
Some Internet functions used on a PC are not available from the TV.	<ul style="list-style-type: none"> • The TV has only limited functions compared with regular PC browsers.

1.	Part Names
2.	Introduction
3.	Direct Button Operation
4.	On-Screen Display Menu
5.	Application
6.	Using a PC
7.	Using the touch function
8.	Appendix
1.	Setting the TV on the Wall
2.	Troubleshooting
9.	Specifications
10.	Trademarks
11.	Dimensional Drawings



Problem	Possible Solution
No sound.	<ul style="list-style-type: none"> • Is connection to other components correct? • Is the volume too low? • Have you pressed MUTE on the remote control unit? • Check the audio output of the connected external equipment. Is the volume too low or muted? • When external equipment is connected via an HDMI cable, you may need to configure the audio to be output through the HDMI cable.

Cautions regarding use in high and low temperature environments.

- When the unit is used in a low temperature space (e.g. room, office), the picture may leave trails or appear slightly delayed. This is not a malfunction, and the unit will recover when the temperature returns to normal.
- Do not leave the unit in a hot or cold location. Also, do not leave the unit in a location exposed to direct sunlight or near a heater, as this may cause the cabinet to deform and the front panel to malfunction.
- Storage temperature: -4° F to +140° F (-20° C to +60° C).



Item		4P-B43EJ2U	4P-B50EJ2U	4P-B55EJ2U	4P-B65EJ2U
LCD Panel		43" Class (42 33/64" Diagonal)	50" Class (49 33/64" Diagonal)	55" Class (54 33/64" Diagonal)	65" Class (64 17/32" Diagonal)
Resolution		8,294,400 pixels (3840 x 2160)			
Video color system		NTSC-M/PAL-N/PAL-M			
TV Function	TV- Standard (CCIR)	American TV Standard ATSC/NTSC System			
	Receiving Channel	VHF/UHF	VHF 2-13ch, UHF 14-69ch		
		CATV	1-135ch (non-scrambled channel only)		
		Digital Terrestrial Broadcast (8VSB)	2-69ch		
		Digital cable*1 (64/256 QAM)	1-135ch (non-scrambled channel only)		
STEREO/BILINGUAL		BTSC system			
Audio amplifier		8 W x 2			
Terminals	Antenna terminal ANTENNA/CABLE IN (Antenna input)	75Ω Unbalance, F Type x 1 for Analog (VHF/UHF/CATV) and Digital (AIR/CABLE)			
	SERVICE ONLY Ø3.5 mm jack	Ø3.5 mm jack			
	INPUT 1 (ARC) HDMI	HDMI (HDMI input), ARC			
	INPUT 2 HDMI	HDMI (HDMI input)			
	INPUT 3 HDMI	HDMI (HDMI input)			
	AV IN (INPUT 3)	AUDIO in, VIDEO in			
	AUDIO OUT	AUDIO out, Headphone (Ø3.5 mm stereo)			
	USB 1	Photo/Music/Video mode, Software update			
	USB 2	Photo/Music/Video mode, Software update			
	EX-IR	External IR receiver connector			
ETHERNET (10/100 BASE-T)	Network connector				
OSD language		English/French/Spanish			
Power Requirement		AC 120 V, 60 Hz			
Power Consumption		98W	130W	130W	180W
Dimensions with stands		958 x 226 x 612 mm	1112 x 243 x 672 mm	1228 x 243 x 742 mm	1446 x 285 x 870 mm
Dimensions without stands		958 x 72 x 558 mm	1112 x 70 x 642 mm	1228 x 73 x 711 mm	1446 x 73 x 835 mm
Weight/Weight without stands		6.9 kg/6.6 kg	10.0 kg/9.8 kg	13.0 kg/12.8 kg	16.8 kg/16.4 kg
Operating temperature		0°C to +40°C			

*1 Emergency alert messages via Cable are unreceivable.

- As a part of policy of continuous improvement, SHARP reserves the right to make design and specification changes for product improvement without prior notice. The performance specification figures indicated are nominal values of production units. There may be some deviations from these values in individual units.
- Continuous operating time and warranty. This product is designed for a maximum daily use of 16 hours. Continual use in excess of 16 hours per day is not covered by the warranty.

NOTE

- Installing the Liquid Crystal Television requires special skill that should only be performed by qualified service personnel. Customers should not attempt to do the work themselves. SHARP bears no responsibility for improper mounting or mounting that results in accident or injury.
- Carefully read the instructions that come with the bracket before beginning work.



Item		4P-B75EJ2U	4P-B86EJ2U	
LCD Panel		75" Class (75" Diagonal)	86" Class (85 9/16" Diagonal)	
Resolution		8,294,400 pixels (3840 x 2160)		
Video color system		NTSC-M/PAL-N/PAL-M		
TV Function	TV- Standard (CCIR)	American TV Standard ATSC/NTSC System		
	Receiving Channel	VHF/UHF	VHF 2-13ch, UHF 14-69ch	
		CATV	1-135ch (non-scrambled channel only)	
		Digital Terrestrial Broadcast (8VSB)	2-69ch	
		Digital cable*1 (64/256 QAM)	1-135ch (non-scrambled channel only)	
STEREO/BILINGUAL		BTSC system		
Audio amplifier		8 W x 2		
Terminals	Antenna terminal ANTENNA/CABLE IN (Antenna input)	75Ω Unbalance, F Type x 1 for Analog (VHF/UHF/CATV) and Digital (AIR/CABLE)		
	SERVICE ONLY Ø3.5 mm jack	Ø3.5 mm jack		
	INPUT 1 (ARC) HDMI	HDMI (HDMI input), ARC		
	INPUT 2 HDMI	HDMI (HDMI input)		
	INPUT 3 HDMI	HDMI (HDMI input)		
	AV IN (INPUT 3)	AUDIO in, VIDEO in		
	AUDIO OUT	AUDIO out, Headphone (Ø3.5 mm stereo)		
	USB 1	Photo/Music/Video mode, Software update		
	USB 2	Photo/Music/Video mode, Software update		
	EX-IR	External IR receiver connector		
ETHERNET (10/100 BASE-T)	Network connector			
OSD language		English/French/Spanish		
Power Requirement		AC 120 V, 60 Hz		
Power Consumption		300W	380W	
Dimensions with stands		1674 x 331 x 1024 mm	1924 x 92.9 x 1102.2 mm	
Dimensions without stands		1674 x 75 x 960 mm	1924 x 441 x 1182 mm	
Weight/Weight without stands		28.9 kg/28.2 kg	56.1/43.4kg	
Operating temperature		0°C to +40°C		

*1 Emergency alert messages via Cable are unreceivable.

- As a part of policy of continuous improvement, SHARP reserves the right to make design and specification changes for product improvement without prior notice. The performance specification figures indicated are nominal values of production units. There may be some deviations from these values in individual units.
- Continuous operating time and warranty. This product is designed for a maximum daily use of 16 hours. Continual use in excess of 16 hours per day is not covered by the warranty.

NOTE

- Installing the Liquid Crystal Television requires special skill that should only be performed by qualified service personnel. Customers should not attempt to do the work themselves. SHARP bears no responsibility for improper mounting or mounting that results in accident or injury.
- Carefully read the instructions that come with the bracket before beginning work.



1.	Part Names
2.	Introduction
3.	Direct Button Operation
4.	On-Screen Display Menu
5.	Application
6.	Using a PC
7.	Using the touch function
8.	Appendix
9.	Specifications
1.	TV (4P-B43EJ2U / 4P-B50EJ2U / 4P-B55EJ2U / 4P-B65EJ2U / 4P-B75EJ2U / 4P-B86EJ2U)
2.	TV (4W-B55FT5U / 4W-B65FT5U / 4W-B75FT5U / 4P-B86FT5U)
3.	Wireless LAN
10.	Trademarks
11.	Dimensional Drawings

Item		4W-B55FT5U	4W-B65FT5U	4W-B75FT5U	4W-B86FT5U
LCD Panel		55" Class (54 33/64" Diagonal)	65" Class (64 17/32" Diagonal)	75" Class (75" Diagonal)	86" Class (85 9/16" Diagonal)
Resolution		8,294,400 pixels (3840 x 2160)			
Video color system		NTSC-M/PAL-N/PAL-M			
TV Function	TV- Standard (CCIR)	American TV Standard ATSC/NTSC System			
	Receiving Channel	VHF/UHF	VHF 2-13ch, UHF 14-69ch		
		CATV	1-135ch (non-scrambled channel only)		
		Digital Terrestrial Broadcast (8VSB)	2-69ch		
		Digital cable*1 (64/256 QAM)	1-135ch (non-scrambled channel only)		
STEREO/BILINGUAL		BTSC system			
Audio amplifier		8 W x 2			
Terminals	Antenna terminal ANTENNA/CABLE IN (Antenna input)	75Ω Unbalance, F Type x 1 for Analog (VHF/UHF/CATV) and Digital (AIR/CABLE)			
	SERVICE ONLY Ø3.5 mm jack	Ø3.5 mm jack			
	INPUT 1 (ARC) HDMI	HDMI (HDMI input), ARC			
	INPUT 2 HDMI	HDMI (HDMI input)			
	INPUT 3 HDMI	HDMI (HDMI input)			
	AV IN (INPUT 3)	AUDIO in, VIDEO in			
	AUDIO OUT	AUDIO out, Headphone (Ø3.5 mm stereo)			
	USB 1	Photo/Music/Video mode, Software update			
	USB 2	Photo/Music/Video mode, Software update			
	EX-IR	External IR receiver connector			
	ETHERNET (10/100 BASE-T)	Network connector			
Interactivity	Touch Technology	IR (infrared blocking detection method)			
	PC Connection Port	USB Type Cx 1 (a USB cable and a C-to-A adapter included)			
	Multi Touch	20 points			
	Protection Glass	Thickness: Approx. 4.0mm Shock resistance: 130 cm			
OSD language		English/French/Spanish			
Power Requirement		AC 120 V, 60 Hz			
Power Consumption		130W	180W	300W	380W
Dimensions		1,264.5 x 83.7 x 749.3 mm	1,483.6 x 83.6 x 872.8 mm	1,705.9 x 87.5 x 996.2 mm	1,955.1 x 105.5 x 1,143.2 mm
Weight		23.4 kg	31.3 kg	51 kg	68.2 kg
Operating temperature		0°C to +40°C			

*1 Emergency alert messages via Cable are unreceivable.

- As a part of policy of continuous improvement, SHARP reserves the right to make design and specification changes for product improvement without prior notice. The performance specification figures indicated are nominal values of production units. There may be some deviations from these values in individual units.
- Continuous operating time and warranty. This product is designed for a maximum daily use of 16 hours. Continual use in excess of 16 hours per day is not covered by the warranty.

NOTE

- Installing the Liquid Crystal Television requires special skill that should only be performed by qualified service personnel. Customers should not attempt to do the work themselves. SHARP bears no responsibility for improper mounting or mounting that results in accident or injury.
- Carefully read the instructions that come with the bracket before beginning work.



Specification	
Standard	IEEE 802.11b/g/n/ac
Security	Static WEP (64/128 bit key index 1 only) WPA-PSK (TKIP) WPA2-PSK (AES)
Modulation	IEEE802.11b: DBPSK, DQPSK, CCK / DSSS HRDSSS IEEE802.11g: BPSK, QPSK, 16QAM, DBPSK, DQPSK, CCK, PBCC / OFDM IEEE802.11n: BPSK, QPSK, 16QAM, 64QAM / OFDM
Throughput	IEEE802.11b: 1, 2.5, 5, 11Mbps IEEE802.11g: 6, 9, 12, 18, 24, 36, 48, 54Mbps IEEE802.11n: ~300Mbps

1. [Part Names](#)2. [Introduction](#)3. [Direct Button Operation](#)4. [On-Screen Display Menu](#)5. [Application](#)6. [Using a PC](#)7. [Using the touch function](#)8. [Appendix](#)9. [Specifications](#)

1. [TV \(4P-B43EJ2U / 4P-B50EJ2U / 4P-B55EJ2U / 4P-B65EJ2U / 4P-B75EJ2U / 4P-B86EJ2U\)](#)

2. [TV \(4W-B55FT5U / 4W-B65FT5U / 4W-B75FT5U / 4P-B86FT5U\)](#)

3. [Wireless LAN](#)

10. [Trademarks](#)11. [Dimensional Drawings](#)

- 1. [Part Names](#)
- 2. [Introduction](#)
- 3. [Direct Button Operation](#)
- 4. [On-Screen Display Menu](#)
- 5. [Application](#)
- 6. [Using a PC](#)
- 7. [Using the touch function](#)
- 8. [Appendix](#)
- 9. [Specifications](#)
- 10. [Trademarks](#)
- 11. [Dimensional Drawings](#)



Manufactured under license from Dolby Laboratories. Dolby, Dolby Audio and Doble-D symbol are trademarks of Dolby Laboratories Licensing Corporation.

The terms HDMI, HDMI High-Definition Multimedia Interface, HDMI trade dress and the HDMI Logos are trademarks or registered trademarks of HDMI Licensing Administrator, Inc.

- 1. Part Names
- 2. Introduction
- 3. Direct Button Operation
- 4. On-Screen Display Menu
- 5. Application
- 6. Using a PC
- 7. Using the touch function
- 8. Appendix
- 9. Specifications
- 10. Trademarks
- 11. Dimensional Drawings

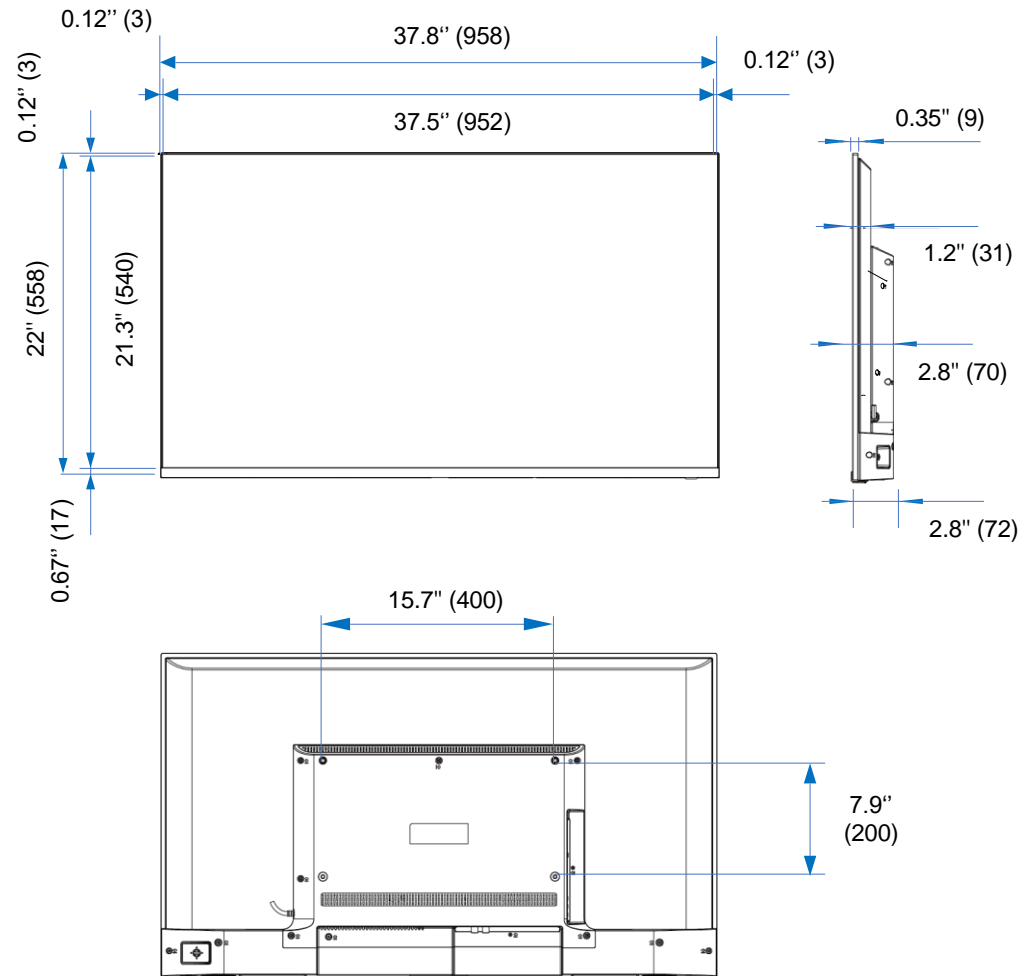

Unit inch (mm)

- 1. Part Names
- 2. Introduction
- 3. Direct Button Operation
- 4. On-Screen Display Menu
- 5. Application
- 6. Using a PC
- 7. Using the touch function
- 8. Appendix
- 9. Specifications
- 10. Trademarks
- 11. Dimensional Drawings

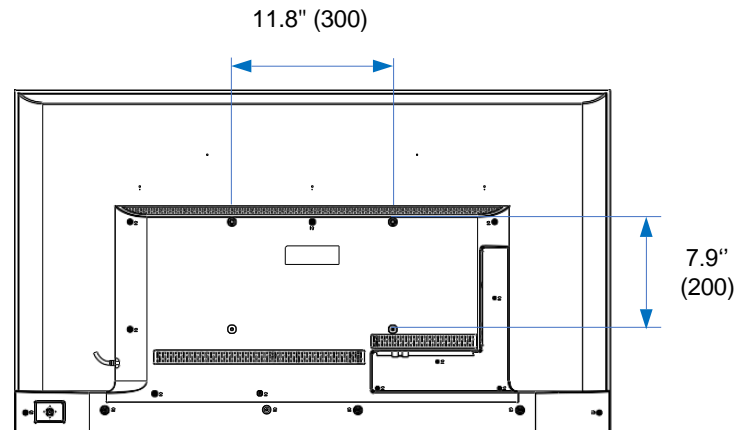
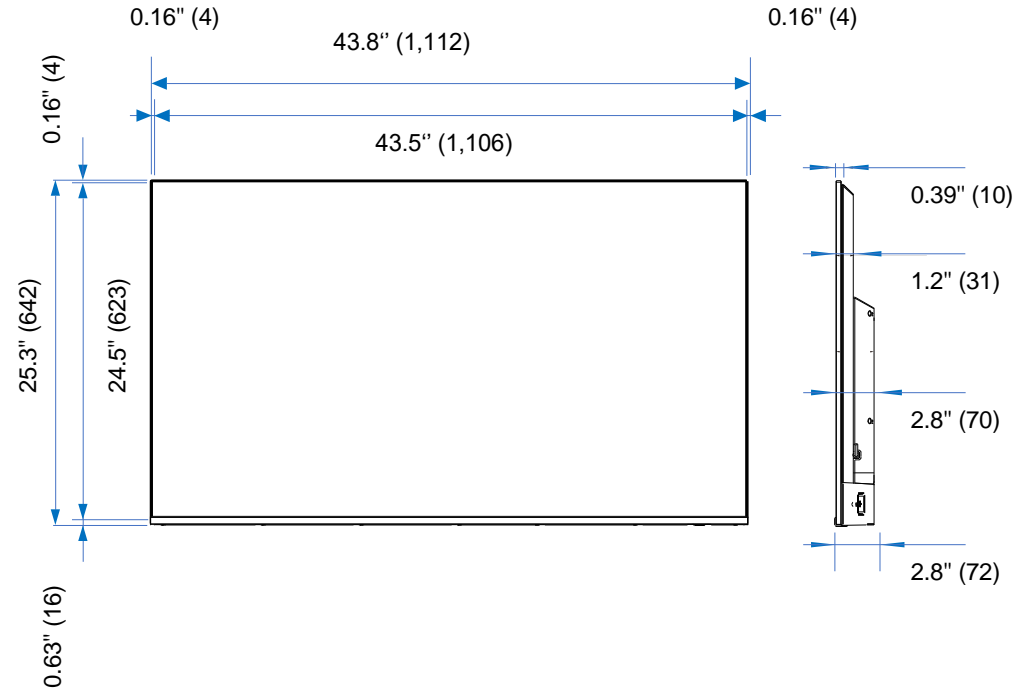

- 1. Part Names
- 2. Introduction
- 3. Direct Button Operation
- 4. On-Screen Display Menu
- 5. Application
- 6. Using a PC
- 7. Using the touch function
- 8. Appendix
- 9. Specifications
- 10. Trademarks
- 11. Dimensional Drawings

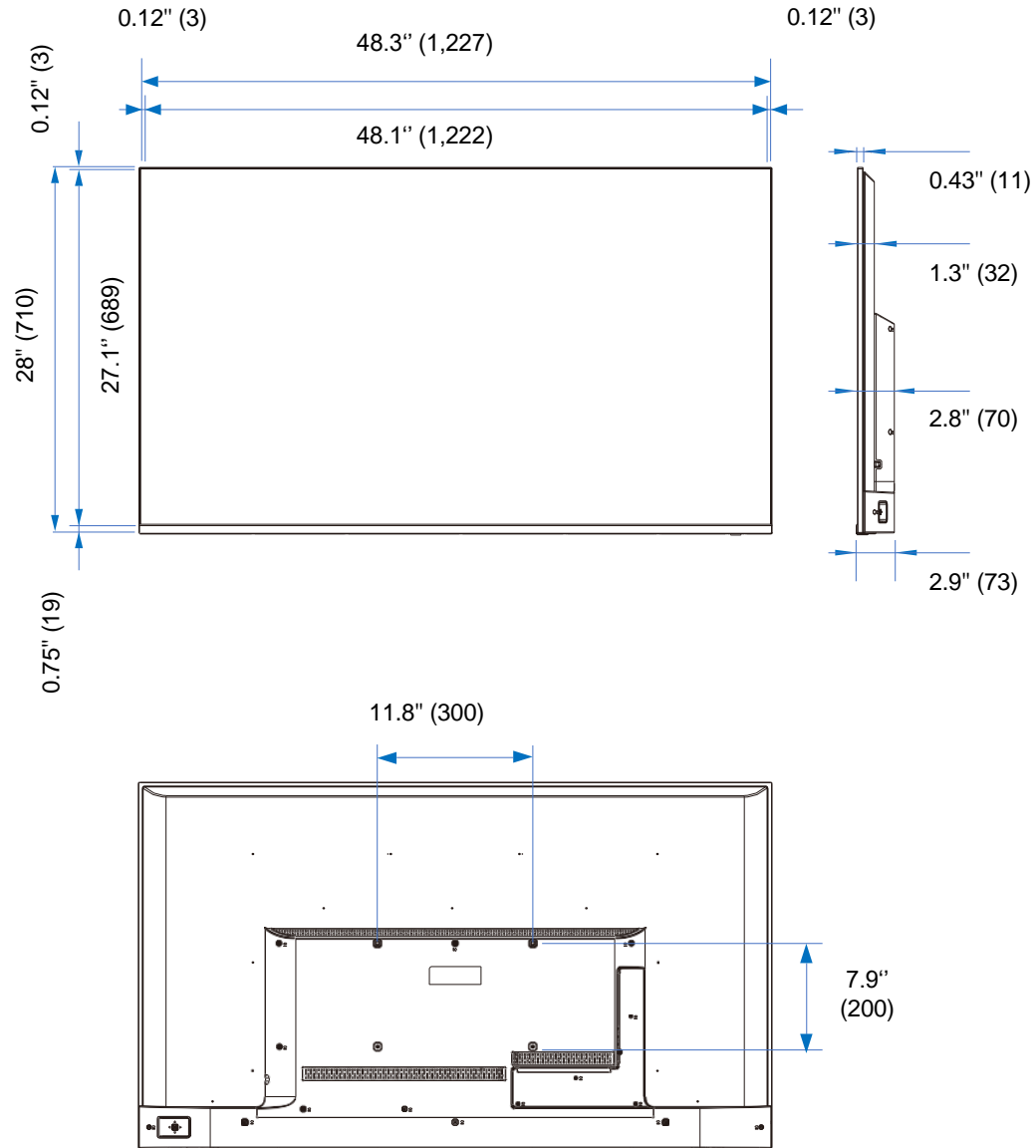

Unit inch (mm)

- 1. Part Names
- 2. Introduction
- 3. Direct Button Operation
- 4. On-Screen Display Menu
- 5. Application
- 6. Using a PC
- 7. Using the touch function
- 8. Appendix
- 9. Specifications
- 10. Trademarks
- 11. Dimensional Drawings

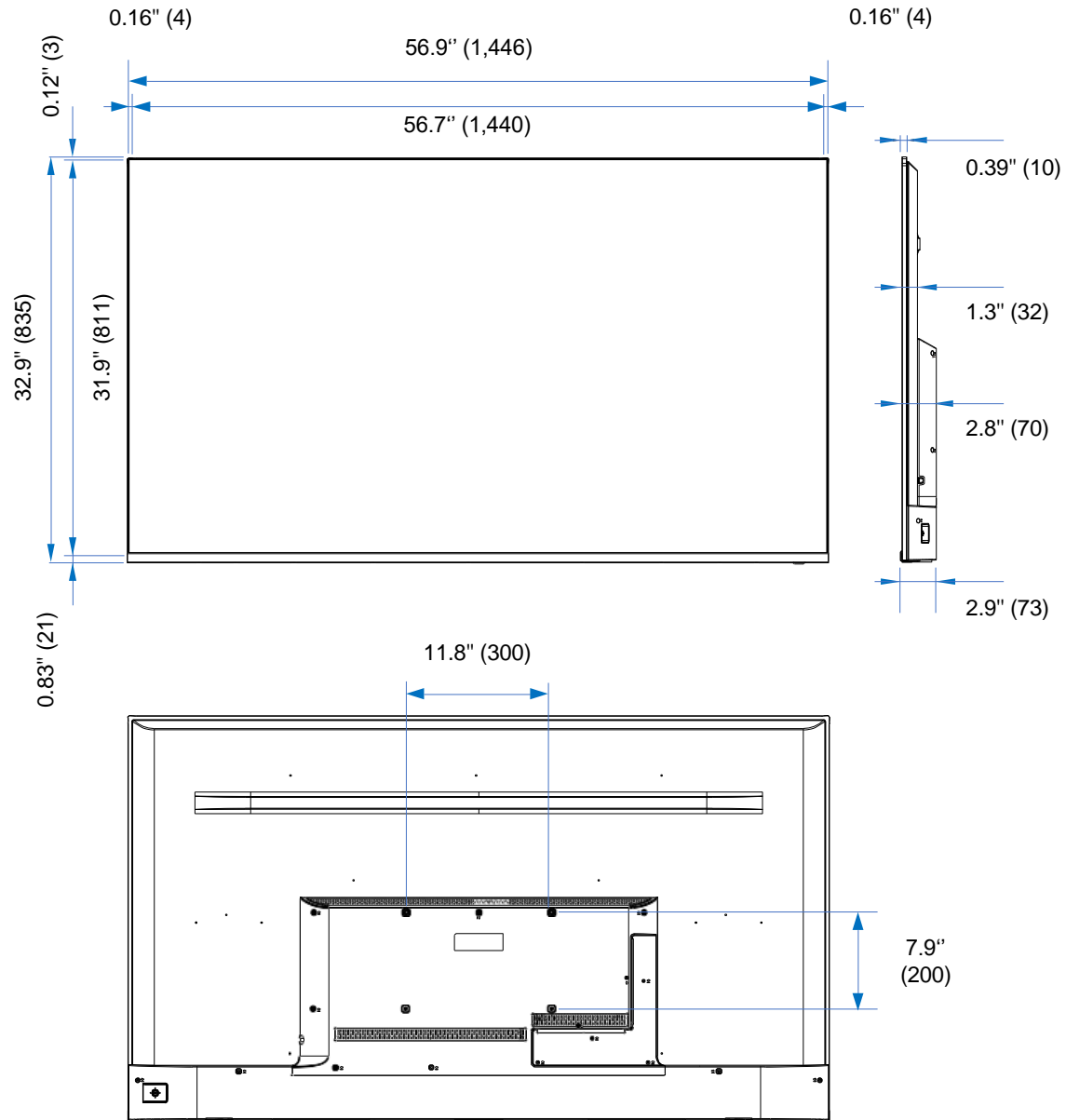

Unit inch (mm)

- 1. Part Names
- 2. Introduction
- 3. Direct Button Operation
- 4. On-Screen Display Menu
- 5. Application
- 6. Using a PC
- 7. Using the touch function
- 8. Appendix
- 9. Specifications
- 10. Trademarks
- 11. Dimensional Drawings

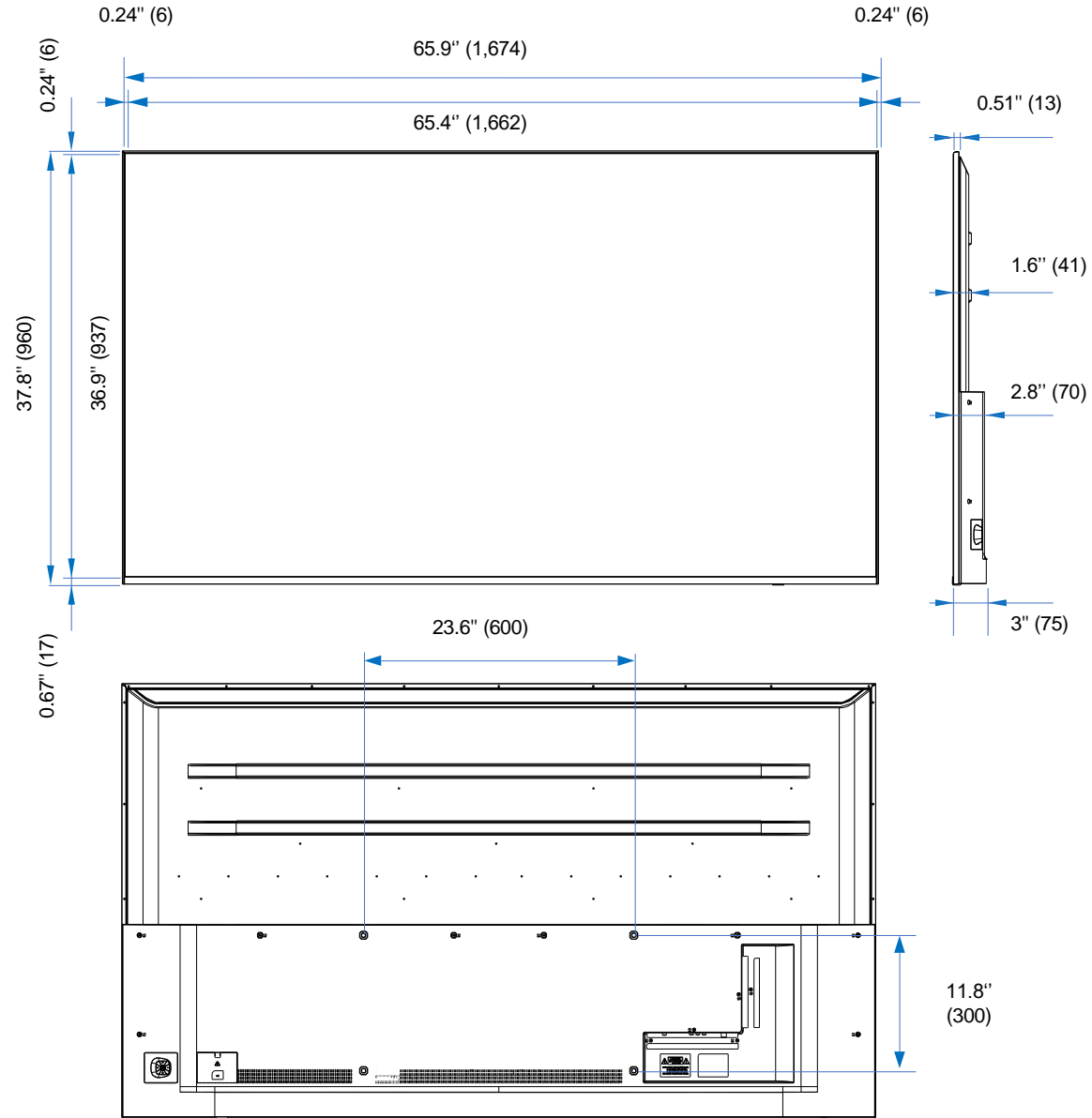

Unit inch (mm)

- 1. Part Names
- 2. Introduction
- 3. Direct Button Operation
- 4. On-Screen Display Menu
- 5. Application
- 6. Using a PC
- 7. Using the touch function
- 8. Appendix
- 9. Specifications
- 10. Trademarks
- 11. Dimensional Drawings

Unit : inch (mm)

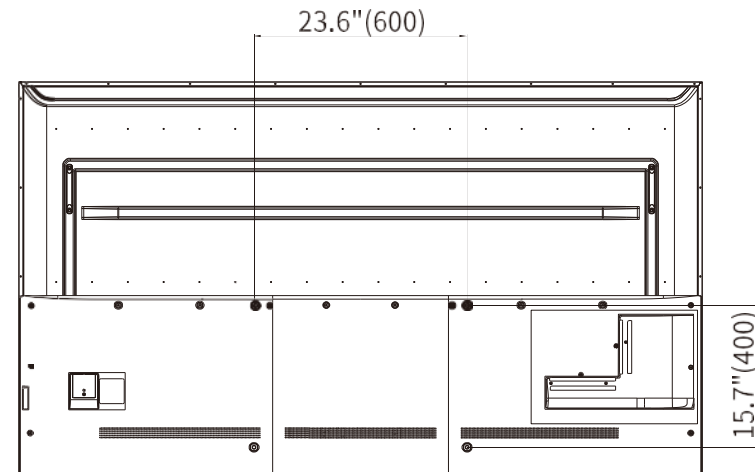
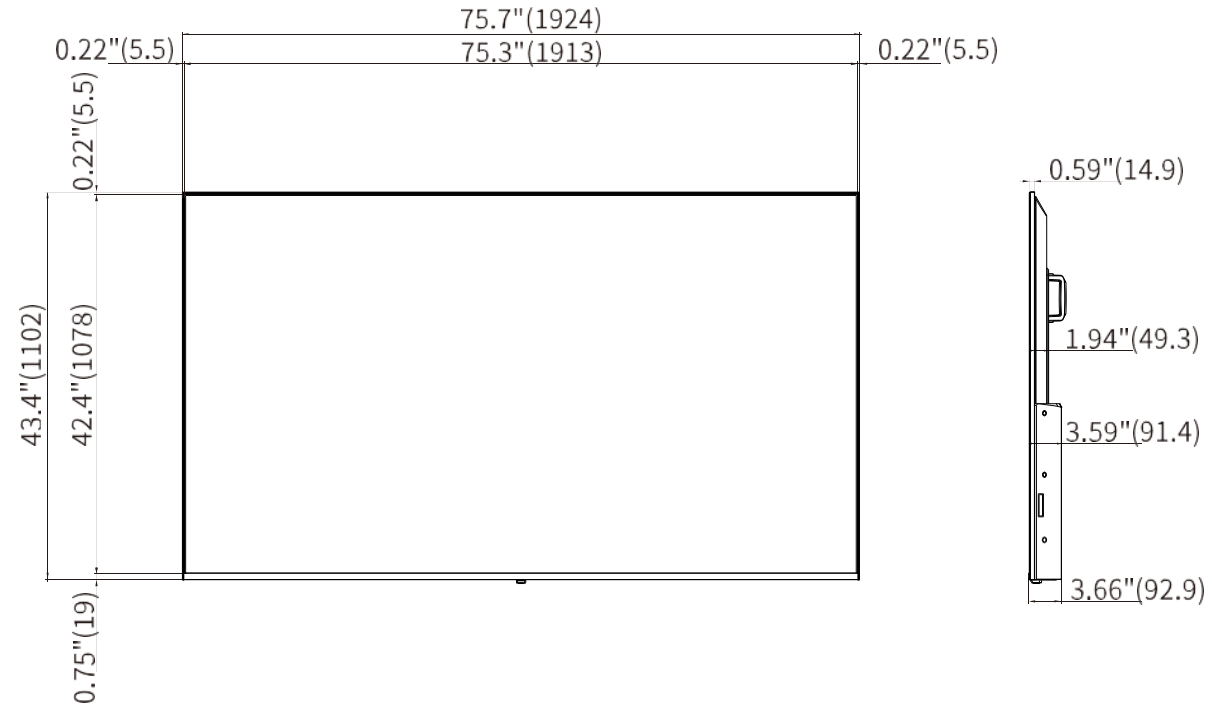

- 1. Part Names
- 2. Introduction
- 3. Direct Button Operation
- 4. On-Screen Display Menu
- 5. Application
- 6. Using a PC
- 7. Using the touch function
- 8. Appendix
- 9. Specifications
- 10. Trademarks
- 11. Dimensional Drawings

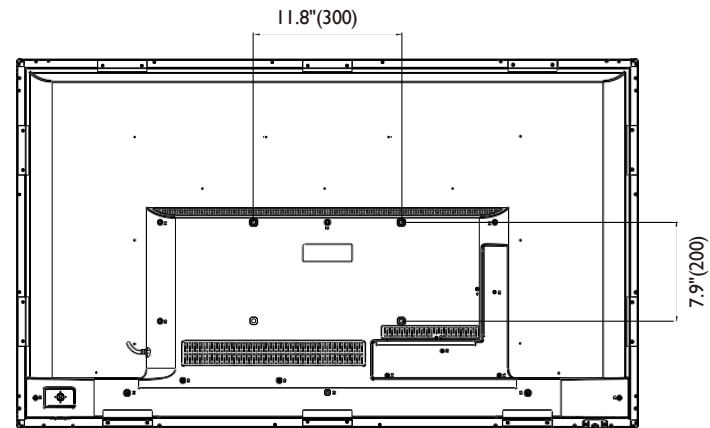
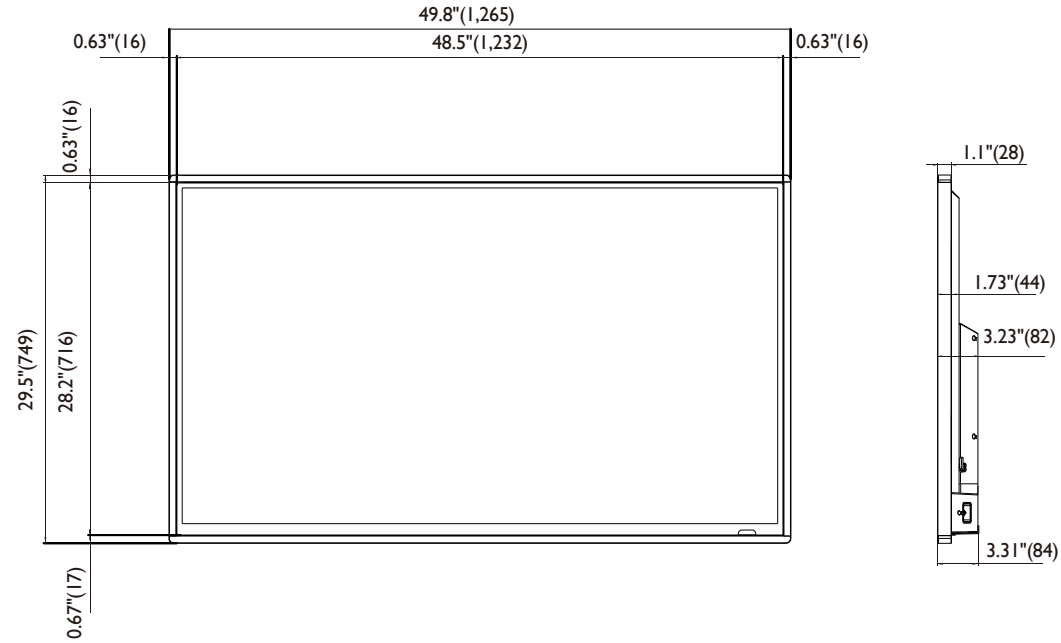

- 1. Part Names
- 2. Introduction
- 3. Direct Button Operation
- 4. On-Screen Display Menu
- 5. Application
- 6. Using a PC
- 7. Using the touch function
- 8. Appendix
- 9. Specifications
- 10. Trademarks
- 11. Dimensional Drawings

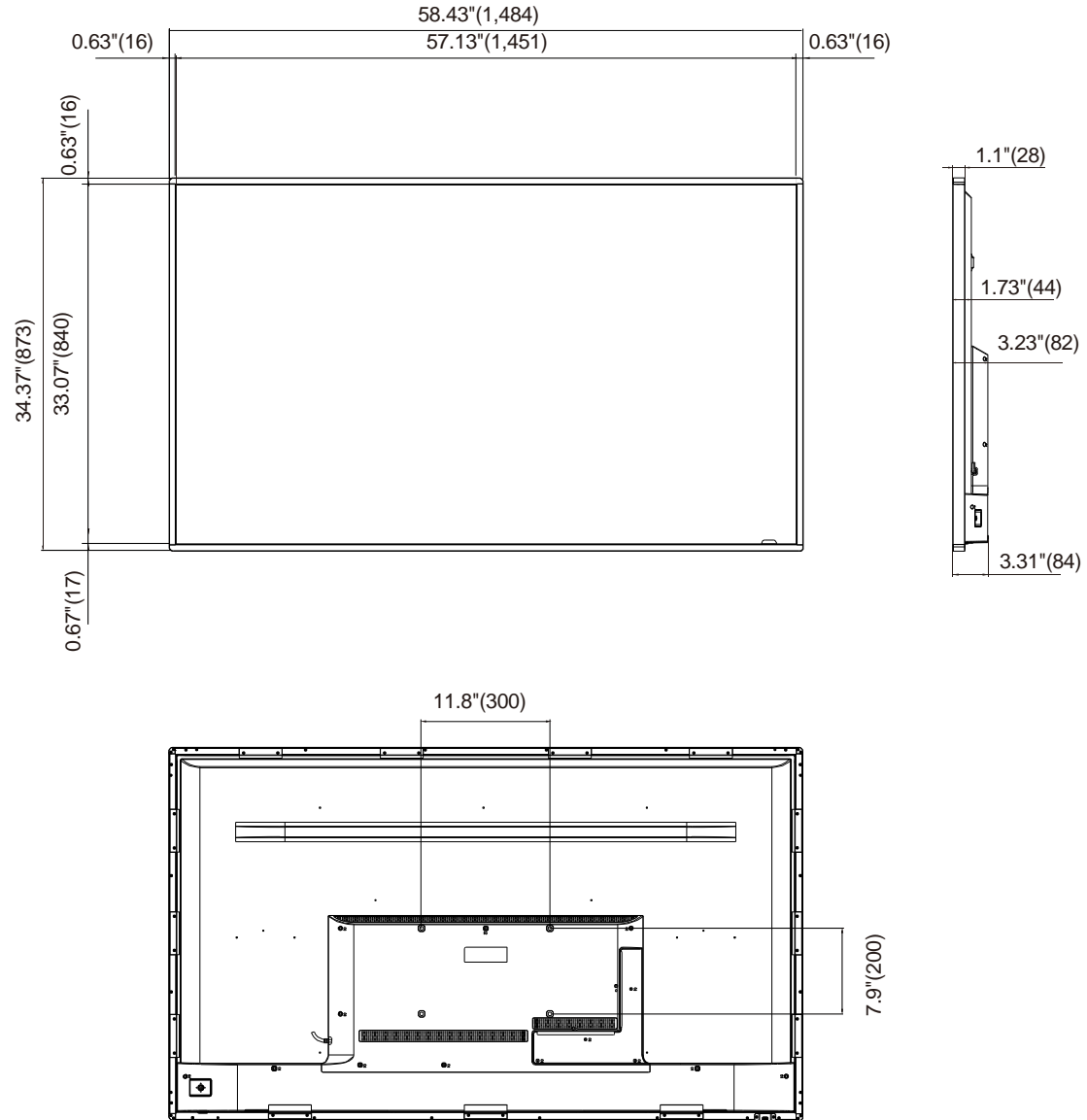

Unit inch (mm)

- 1. Part Names
- 2. Introduction
- 3. Direct Button Operation
- 4. On-Screen Display Menu
- 5. Application
- 6. Using a PC
- 7. Using the touch function
- 8. Appendix
- 9. Specifications
- 10. Trademarks
- 11. Dimensional Drawings

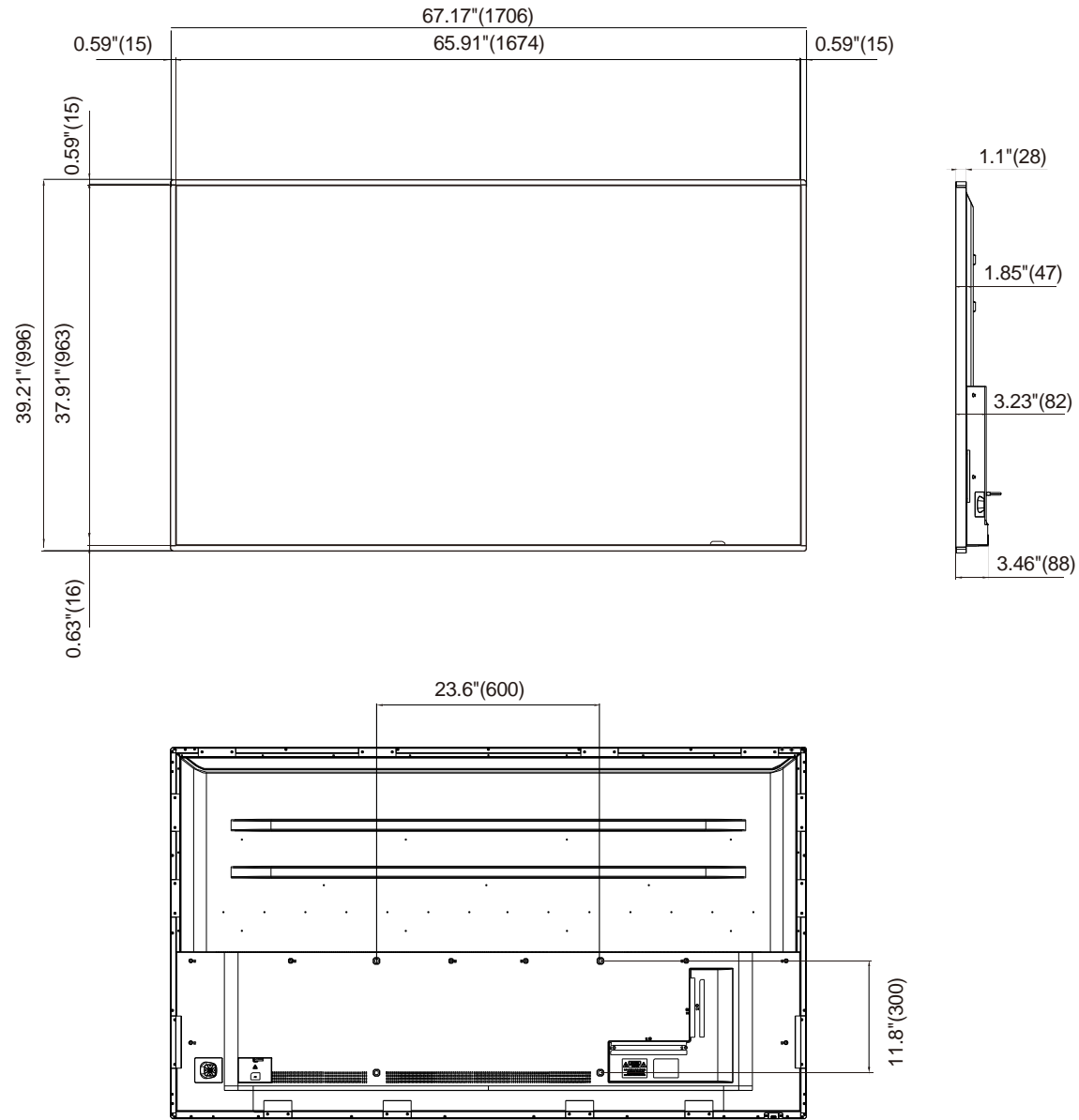

Unit inch (mm)

- 1. Part Names
- 2. Introduction
- 3. Direct Button Operation
- 4. On-Screen Display Menu
- 5. Application
- 6. Using a PC
- 7. Using the touch function
- 8. Appendix
- 9. Specifications
- 10. Trademarks
- 11. Dimensional Drawings

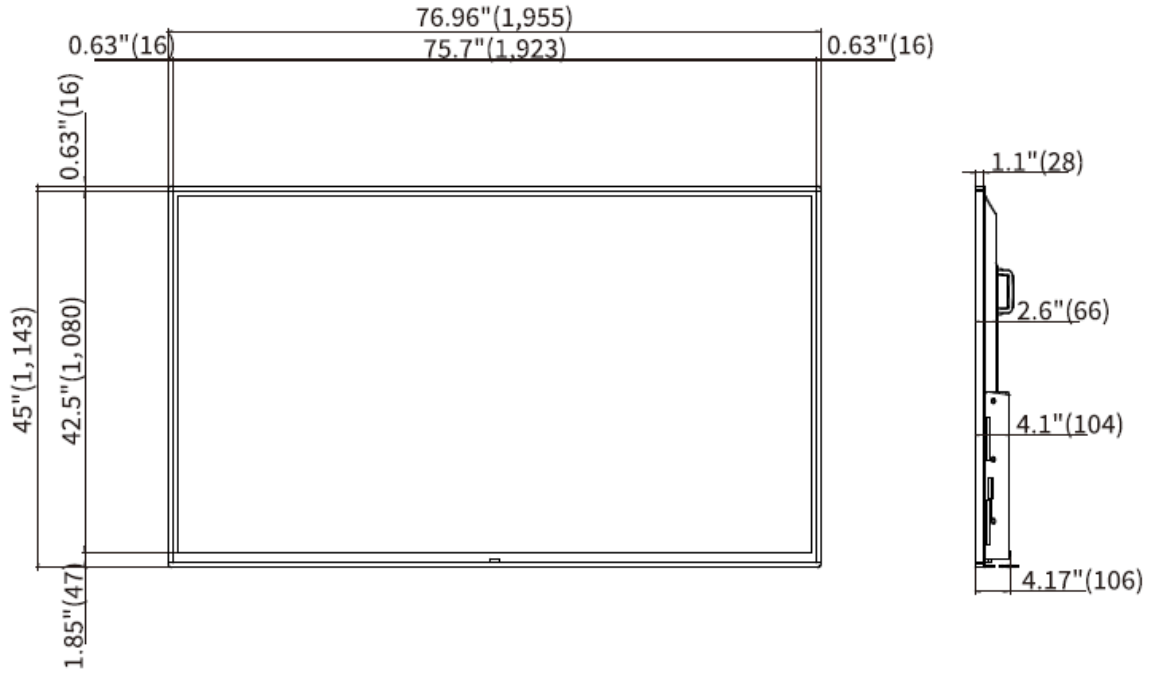

[ENGLISH]

Contents



1. [Part Names](#)
2. [Introduction](#)
3. [Direct Button Operation](#)
4. [On-Screen Display Menu](#)
5. [Application](#)
6. [Using a PC](#)
7. [Using the touch function](#)
8. [Appendix](#)
9. [Specifications](#)
10. [Trademarks](#)
11. [Dimensional Drawings](#)

